

Colorado
State
University

Extension

MJ1025
Member's Manual



S'mores and More:
**4-H Outdoor Cooking
& Living**

Issued in furtherance of Cooperative Extension work, Acts of May 8 and June 30, 1914, in cooperation with the U.S. Department of Agriculture, Milan A. Rewerts, Director of Cooperative Extension, Colorado State University, Fort Collins, Colorado. Cooperative Extension programs are available to all without discrimination. To simplify technical terminology, trade names of products and equipment occasionally will be used. No endorsement of products named is intended nor is criticism implied of products not mentioned.

01/2003 Reprinted 01/2012



This publication was prepared for use in the Oregon 4-H Home Economics and Natural Resources programs. Some information has been adapted from previous Oregon 4-H Outdoor Cookery materials.

Editors: Miriam Lowrie, professor emeritus; Elaine Husted, Extension faculty, Grant County; R. Roy Hamilton, professor emeritus; all of Oregon State University.

Pilot study process for National 4-H Juried Curriculum Review: Mary Arnold, 4-H Youth Development specialist for curriculum and evaluation, Oregon State University.

Layout and design: Rick Cooper, former OSU Extension and Experiment Station Communications editor.

Curriculum reviewed by: Carolyn A. Raab, Extension Food and Nutrition specialist; Virginia Bourdeau, 4-H Youth Development specialist—Natural resources; Elaine Schrupf, 4-H Youth Development specialist—Home Economics, all of Oregon State University; and Ann Rund, 4-H Extension specialist for curriculum and international programs, University of Illinois.

No endorsement of named products is intended, nor is criticism implied of similar products not mentioned.

Contents

Introduction.....	3
Chapter 1—Down to Basics	
1A. Fuel for Life.....	9
1B. Keep Healthy and Well.....	13
1C. Planning Party	17
1D. Let's Do Lunch	20
Chapter 2—Nutritious Meals and Snacks	
2A. Good Food that Stays Good.....	24
2B. Extraordinary Eats	27
2C. Incredible Edibles	30
2D. Me and My Buddy	34
Chapter 3—Backyard Cookout	
3A. Lay the Groundwork	38
3B. Ready to Help.....	41
3C. Fuel for Fire	46
3D. Safe and Orderly Cooking	50
3E. We Can Cook!	55
Chapter 4—Safety First	
4A. What Shall We Eat Today?.....	60
4B. Our Friend, the Sun.....	63
4C. A Safe Cooking Campfire	67
4D. Out and About	70
Chapter 5—Planning is the Key	
5A. Time for Safe Keeping	73
5B. All Decked Out.....	78
5C. Cooking that Shines	81
5D. Off We Go.....	85
Chapter 6—We're Off!	
6A. Buying Smart	89
6B. Cooking on a Stick.....	93
6C. The Campfire Grill	97
6D. We're Tenting Tonight	101

Introduction

Welcome to the beginning 4-H outdoor cooking project—S'mores and More! If you haven't yet experienced the joys of cooking outdoors, here's your opportunity to roast marshmallows, make your own S'mores, and so much more!

Ever since humans figured out how to make fire, they've been cooking food over a campfire. We continue to share that bond with our ancestors as we sit around the campfire, barbecue grill, or propane stove, talking and planning as we wait patiently for our food to be ready to eat so we have more energy to do the things we've planned in the great outdoors.

While some of you might be "old hands" at cooking in the kitchen, cooking outdoors will present some new challenges. Uneven heat sources, basic cooking equipment, and limited cooking and cleaning facilities are some of the challenges you will face. In addition, you'll need to learn patience, because cooking outdoors is the opposite of the fast food we've become used to in today's fast-paced society.

Whether you're an "old hand" or brand new to cooking, learning the basics of cooking the way our ancestors did—in nature's kitchen—will be fun and exciting. You're learning skills for your whole life that someday could save your life, and skills you'll pass on to others as you grow and go places!

4-H is all about learning life skills—skills that will help you all through your life. You'll be learning skills that will help you:

- Understand yourself
- Communicate and relate with others
- Solve problems and make decisions
- Find, understand, and use information
- Make good use of your resources
- Work with groups
- Think about your future world of work
- Stay healthy and in good physical condition, and refine coordination

Your goal in the 4-H Outdoor Cooking and Living project is to prepare safe food in outdoor settings to keep yourself and others healthy. What could be worse than to go to a beautiful camping spot and then prepare food that's unsafe to eat and have someone get sick? In the 4-H Outdoor Cooking and Living project, you'll learn





about:

- Selecting and preparing healthful food
- Food and fire safety
- Personal and environmental health

We all learn in different ways—by reading, by listening, and by doing. You'll learn best by following these five steps:

1. Do the activities in the book.
2. Share what happened with your friends and parents.
3. Tell them what's important and how it relates to other things you already know.
4. Ask yourself So what? Connect your experience to real-world examples and plan to use these skills in the future.
5. Ask yourself Now what? Apply what happened to other situations, and practice getting better by teaching others what you've learned.

You'll learn even more if you also plan to give talks, demonstrations, or presentations; attend workshops; teach others; construct new items; keep records; exhibit your projects; and participate in all of your group's outdoor cooking activities. Your adult helper will help you set goals, plan activities, suggest resources, and talk over what you've learned. Your helper will support you and all that you do, meet with you regularly, and also might be the one to go on hikes and camping trips with you. If your helper cannot go with you on these outdoor adventures, find another adult who can accompany you and your group.

Your adult helper will work with you to figure out what other knowledge and skills you need to stay safe and healthy. For example, anytime you use fire or another heat source, have a first-aid kit available.

Start an Outdoor Cooking and Living journal. This helps you track new skills, knowledge, and activities. Always bring your notebook and pencil to meetings.

The 4-H Outdoor Cooking and Living project is divided into three levels—Basic, Expanding, and Advanced. No matter what age you are when you start Outdoor Cooking, you must start at the beginning level in order to learn the basics upon which everything else is based. As you gain confidence close to home, you, your friends, and your adult helper might want to go on longer trips away from home and even, perhaps, to remote areas of your region. Your leaders, helpers, and parents will help you decide when you're ready to take the next step.

Now get ready for S'mores and More! We hope you enjoy it.

Here's what you'll be learning in this first book:

Nutrition and meal planning

- What is the Food Pyramid?
 - Planning well-balanced meals
- Nutrients for good health
 - Protein, carbohydrates, fats, vitamins, minerals, fiber, water
 - Just as a fire needs fuel to keep going, so does a camper
- Good food for camping/outdoor cooking
 - Nutrient- and calorie-rich, light in weight, minimum packaging, easy to fix
- Making menus—how much do I need?
- Buying foods at the supermarket
 - Convenience foods vs. scratch ingredients
 - Making some of my own convenience foods: drink mixes and trail mixes
- Time management
 - What to fix first so everything is ready at about the same time

Food safety

- General food safety
 - Keep food clean, hot, cold; cook thoroughly
 - Food temperature danger zone
- Sanitary conditions
 - Keep hands and cooking surfaces clean.
- Clean dishes—rinse away soap so it doesn't get inside you!
 - Use bleach to sanitize surfaces.
- How to keep foods frozen or cold
 - Cooling/insulation systems
- Easy foods to prepare
 - How do I know foods are “done”?
- Safe storage of foods and leftovers

Fire-building/safety and environmental health

- Campfire safety
- What fire needs to burn
- Prepare the area
 - Barbecue grill
 - Cooking fire
 - Storage of cooking equipment
- Selecting appropriate fuel
 - Briquettes
 - Types of wood and how they burn
 - Other fuels
- Starting a cooking fire
- Putting out a cooking fire





- Safe use of knife/ax/starter fluids
- Cleanup
- General fire regulations
 - Size, control, tools, guard, dead out
- Keeping the environment and people safe
 - Trail, rules, registration, plants and wildlife

Food preparation methods

- Packed/picnic lunches
- No-bake meals
- Trail mixes/snacks
- Cooking on a stick
- Barbecue grilling
- Solar cooking

Outdoor cooking and self-sufficiency equipment

- Insulated lunch bag
- Small solar cooker
- BBQ apron
- Waterproof matches and holder
- Fire starters
- Tin-can stove
- On-the-spot backpack
- Personal mess kit and storage bags

Personal camp safety and first aid

- Camp hazard identification
- Preventing cuts and burns
- First aid
- Heimlich maneuver for choking
- Make a first-aid kit
- Make a survival backpack
- Awareness of surroundings
 - Wildlife, water, tides
- Clothing to wear
 - Fabrics that are best, layering, sturdy shoes, no loose clothing

Working with and respecting others

- Learn camp manners
- Respect for the land, others' property, other people, and yourself
- Plan roles and responsibilities for all campers
 - Fit roles to abilities, teams, support

INTRODUCTION

- Design and set up the food crew
 - Planning, buying, set up, cooking, clean up

Plan, do, and evaluate

- Camping planning guide
- Plan and go on a picnic (one meal)
- Plan and go on a day hike (one meal and snacks)
- Plan and go on a summer campout (three meals and snacks)
- Evaluate each experience

Suggested exhibit guidelines

- Box lunch—judge safety only (not the look of the box)
- 1 cup of instant drink mix appropriately packaged
- One safe camping setup with a fire model
- Educational poster on first aid, safety, or a related topic
- Equipment made by exhibitor
- Contest—Cook one food on a grill



Chapter 1—Down to Basics

1A. Fuel for Life

Evelyn Brookhyser, Extension 4-H agent, Lincoln County, Oregon State University

Here's what's important

Respect fire for life

Fire burns fuel to provide heat energy for outdoor cooking. In this outdoor cooking project, you'll learn the common fuel sources for outdoor cooking and how to use them. Fire safety and control are important to remember every time you are around fires. During the dry seasons, many areas restrict burning due to potential wildfires. You always must consider fire danger before planning to cook with fire.

Wood is the oldest fuel for cooking, but it is becoming scarce today. Campfires add to the wilderness experience, but remember some areas are very fragile. Collecting wood and leaving a fire scar on the land will alter the environment.

If you make a fire, always have someone watch it. Keep firefighting equipment and materials (bucket, shovel, water, or sand) on hand. Break used matches in two and make sure the head is cold enough to touch before throwing it in the garbage.

You must know how to put out a cooking fire. Fire needs oxygen to burn, so cut off the air. To put out coals in a covered barbecue grill, cover and shut off all air to the coals. In a cooking fire, drench hot coals with water and stir with a stick until all the coals are soaked. Turn larger sticks and logs and drench on both sides. You also can cover the hot coals with sand or dirt. Start around the outer edge of the fire and add sand or soil; tramp it down and then check carefully with your hand to make sure the soil is cool. Get an adult to help you with this important job.

Choose foods for life

Just as a fire needs oxygen and fuel to burn, your body needs the air you breathe and food as fuel to make it go, work, and play. Food nutrients and calories are absorbed into every cell in your body to keep you growing and going. Eat a variety of foods, using the Food Pyramid (Figure 1, page 10) as a guide, to stay healthy and have enough energy to do the things you like to do.

To help you understand the Food Guide Pyramid, think of it as a building with six rooms—one for each important food group plus one for foods that aren't nutritious. The bottom "floor" is for breads,

Life skills

- Understanding self
- Finding, understanding, and using information
- Staying healthy and in good physical condition, and refining coordination

Goals

- To know the importance of basic safety when handling fire materials
- To learn that many fuels keep your body working

Supplies needed

- Food Guide Pyramid Poster
- Outline of Food Guide Pyramid (without words or pictures) on poster board
- Variety of measuring cups
- Scale
- Knife
- Variety of foods from each food group



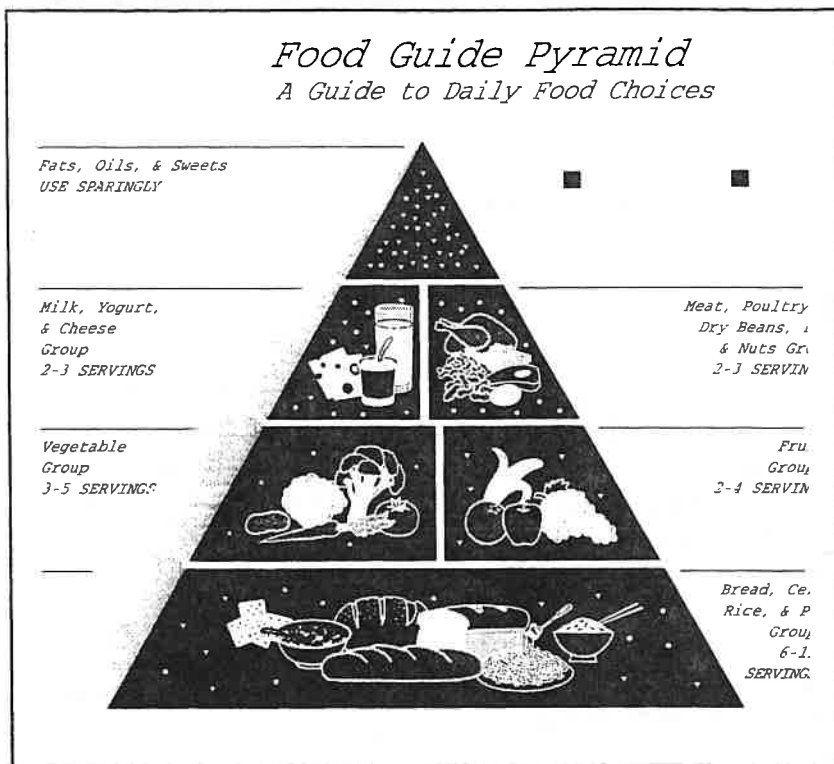

Figure 1

grains, cereals, rice, pasta, and crackers. It gets the largest “room” because you need to eat the most servings of these foods— at least six each day. This food group provides the nutrient called carbohydrate. Carbohydrates are made up of starches and sugars in food that provide energy your body needs to play and work.

Above the base of the pyramid are two rooms: One for vegetables and one for fruits. Notice the vegetable room is a little bigger than the fruit room. You need to eat at least three servings of vegetables and two servings of fruit each day. Vegetables and fruits provide vitamins, minerals, and fiber. They keep your internal body parts healthy and working well.

On the third floor, there are two smaller rooms: one for the milk, cheese, and yogurt group and the other for meat, poultry, fish, dry beans, eggs, nuts, and tofu. Eat at least three servings from the milk group because it provides calcium, which builds strong bones and teeth. Eat at least two servings from the meat group because it is rich in protein. Protein helps you grow and repair all the cells in your body.

Above the third floor is the “attic” where foods you won’t need as often are found. This includes foods that have more fat and sugar than good nutrients, such as fried foods, dressings, sweets, and soft drinks. This group supplies calories with few nutrients. Eat these foods sparingly, because you will fill up on them and miss eating foods high in the nutrients your body needs.

Let’s get into it

Eat Smart Match-Up!

Here are 18 foods. Put the foods into their own section in the Food Pyramid. Corn flakes, baked potato, apple, chocolate milk, tuna, potato chips, tortilla, carrots, banana, yogurt, eggs, candy bar, pasta, green beans, raisins, cheese, peanut butter, soft drink. Did you get them all in their right section? There should be three foods in each section of the Food Pyramid.

How much of each food should you eat? What does one serving look like? Use standard measuring equipment to measure an accurate serving size. Select a variety of foods to measure a serving: dry cereal, bread, rice (cooked and uncooked), pasta (cooked),

1A. FUEL FOR LIFE

apple, banana, canned fruit, juice, peas, lettuce, salad dressing, broccoli, potatoes, egg, hamburger, peanut butter, nuts, milk, cheese, and yogurt. Here are some basic serving sizes:

- Grain Products Group: 1 slice bread; 1 ounce ready-to-eat cereal; ½ cup cooked cereal, rice, or pasta
- Vegetable Group: 1 cup raw leafy vegetables, ½ cup cooked or chopped raw vegetables, ½ cup vegetable juice
- Fruit Group: 1 medium apple, banana or orange; ½ cup chopped, cooked, or canned fruit; ½ cup fruit juice
- Milk & Dairy Group: 1 cup milk or yogurt, 1½ ounces natural cheese, 2 ounces processed cheese
- Meat and Beans Group: 2–3 ounces cooked lean meat, poultry, or fish; ½ cup cooked dry beans or 1 egg counts as 1 ounce lean meat. Two tablespoons of peanut butter or ⅓ cup nuts count as 1 ounce meat.

Read the label on packaged foods to see what one serving size is. How much do you put on your plate when you eat these foods? Do you really know how many servings you're eating? Do you eat a half serving, a whole serving, or more than a serving? Check it out.

There's more

Make a food pyramid. Put pictures of your favorite foods in the right section. Are you eating the recommended number of servings each day from each group?

Write the names of the major nutrients in each section. Read labels to learn about nutrients.

Deeper we go

Look up nutrient information on a Web site, in a USDA Dietary Guidelines bulletin, or in another standard nutrition guide. What nutrients are provided by foods in each section of the food pyramid? What is the standard serving size of all your favorite foods? How does your serving size compare?

Pretend you are planning a long hike. What nutrients are important for muscles to function for a long time? Write down some of your favorite foods that include those nutrients to keep your muscles working well.

So what?

What's important to remember about fire in outdoor cooking? Name some of the fuels fire burns to give you heat for cooking. What else does fire need in order to burn? What are the major nutrients your body needs to keep it fueled and ready to go? Which foods should you eat just in small amounts so you save room for the foods you



Resources

Serving size resource: The Food Guide Pyramid, Home and Garden Bulletin #252, USDA Center for Nutrition Policy and Promotion.

Camping Made Easy, Michael Rutter, The Globe Pequot Press, Old Saybrook, CT, 1997.

<http://www.usda.gov/cnpp>— This site will help you analyze your daily intake of 17 nutrients plus calories from proteins, fats, and carbohydrates.

<http://barbecuen.com>—This site features information from C. Clark “Smoky” Hale, who is an expert on barbecuing. The site is fun and practical.

really need?

Now what?

- Set up a judging contest with four items and figure out which food has the most calcium. Include oranges, broccoli, and tofu, along with a dairy product. Place them 1st, 2nd, 3rd, and 4th best. Check a nutrition label, Web site, or nutrition booklet at your library or Extension office to find out the calcium content of each of these foods and why you need calcium in your diet.
- Make a poster/display of a cooking fire and all the things you need around to keep it safe.
- Write down on paper what you eat in one day. Count how many servings you got from each “room” of the food pyramid. If you don’t meet the basic requirements, plan how you can get all the food you need each day.
- Talk to others who do outdoor cooking and camping. Find out what type of fuel they use for cooking and why. What do they do to keep their outdoor cooking safe?
- Study one or more of the major nutrient groups: vitamins, minerals, carbohydrates, protein, fats, water. Tell others why each nutrient is important.

1B. Keep Healthy and Well

Evelyn Brookhyser, Extension 4-H agent, Lincoln County, Oregon State University

Here's what's important

Food safety

There are always tiny monsters ready to attack your food. They're called germs (or bacteria) and molds. You can't see them with your eyes, but they are visible under a microscope. They live in soil, air, and water and can be found in the bodies of humans and animals.

"Food spoilers," such as mold, change the look and smell of the food. You know not to eat it. "Food poisoners" are trickier because they usually don't change the smell or look of food. You don't know they are there. You might have heard of some of them. Staphylococcus, Salmonella, E. coli, and Listeria cause people to be nauseated and have stomach cramps and diarrhea. Some bacteria are deadly. People who have cancer or AIDS, the very young and very old, or pregnant women can die from these "food poisoners."

The way to avoid food poisoning is to:

Keep it clean!

Start by washing your hands often. A good hand wash is one of the best protections against food poisoning. Wash your hands by soaping well between the fingers, tops of hands, wrists, and fingernails. All of the wrinkles and lines can hide germs. Always wash your hands after using the toilet. To wash long enough to get your hands thoroughly clean, sing "Happy Birthday" to yourself—about 20 seconds—while soaping your hands, and then remember to rinse them well.

Be sure all surfaces where you put food are clean. When cutting raw meat, poultry, or fish, clean and sanitize the knife and cutting board before using them with another food. An easy sanitizing solution is 1 Tablespoon of chlorine bleach to 1 gallon of water. If you are camping and do not have a safe water supply on hand, use an antibacterial wipe to wash your hands. If you're using soap to clean pots, wash the pots at camp—not at the water's edge. Rinse them well. Dump dirty water onto dry ground, well away from fresh water.

Cook it well!

Always use pasteurized milk. Meat, poultry, seafood, and eggs must be well cooked. Hamburgers should have no pink in the middle; chicken juices should be clear; fish should be opaque and flake easily; and egg yolks should not be runny. A small, instant-read thermometer is handy to check for doneness. You are safe if you cook meat and

Life skills

- Problem solving and decision making
- Finding, understanding, and using information
- Staying healthy

Goals

- To learn basic food safety skills
- To know how to apply basic first aid on cuts and burns

Supplies needed

- Sample first-aid kit
- Microscope
- Petri dish with agar (check with a science teacher)

*An easy sanitizing solution is
1 Tablespoon of chlorine bleach to
1 gallon of water.*

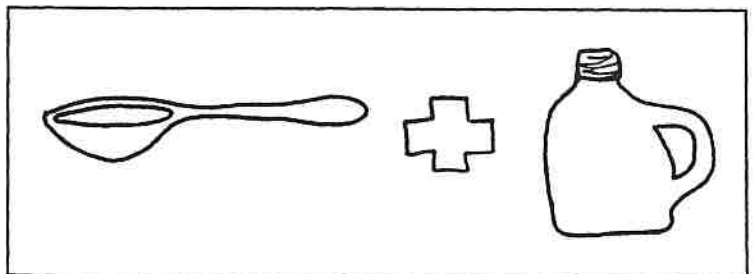

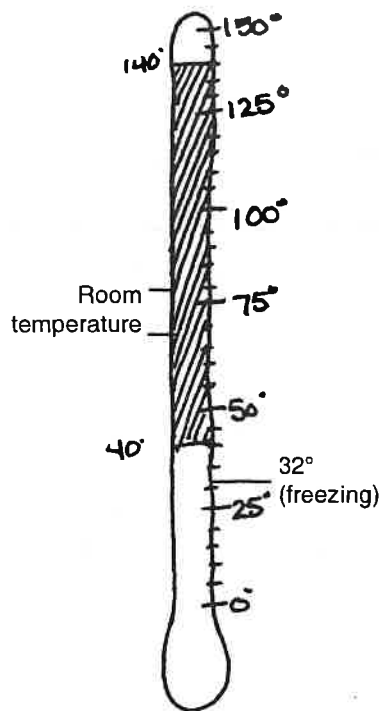

 Danger zone for perishables

poultry to 160°F. Remember, if your meat is still frozen, it will take more time to cook thoroughly.

Cool it soon!

Perishable foods are those that become unsafe to eat after being left out for 2 to 3 hours in the danger zone between 40 and 140°F. This includes many leftovers and deli items. Don't leave them at room temperature. Cool soups and stews quickly by refrigerating them in shallow pans. Blocks of ice keep longer than cubes; make your own by freezing water in a clean, empty, gallon-size milk carton. Frozen gel packs last longer than cubes. Pack double-bagged, frozen meat and poultry and it might still be frozen when you get to your campsite. Pack perishable foods in the order you'll use them, so you can find them quickly and keep the other food cold. For drinks, use a separate cooler, because you open the lid often. Take perishable foods in the smallest size needed so there are no leftovers.

If in doubt, throw it out!

Do not eat any food that might be unsafe! Perishable food should not be kept at temperatures between 40 to 140°F for longer than 2 or 3 hours. It is not safe to save food for another meal unless it has been quickly cooled as soon as you finish eating.

There's more

Cuts and burns are the most common injuries to people cooking outdoors. Assume everything around a fire will be hot—don't test it to see! Sturdy oven mitts are the most important piece of outdoor cooking equipment you can have. For the best protection, look for long ones that have a silver-coated fabric (such as Teflon®) on the palm side of the mitt.

If you or a friend gets a small burn, get the temperature down (cooler) with clean, cool water and protect the skin from infection with a clean bandage. Have an adult help decide whether further treatment is needed.

While sharp knives and axes are dangerous, it's better to have sharp equipment than dull equipment. Learn to cut away from you with a knife, rather than toward you, and always cut on a sanitary surface. A pocket knife is handy for outdoor jobs. Make sure it's kept sharp and clean. If you use it for food preparation, you must clean it in the same way as other silverware to prevent the spread of germs.

If you or a friend gets a small cut, apply pressure to the wound until the bleeding stops. Wash the wound with soap and water, apply antiseptic to the bandage, and bandage firmly. Some people have infectious diseases, such as hepatitis, meningitis, or AIDS, and they can infect you. Wear disposable latex/vinyl gloves when treating

1B. KEEP HEALTHY AND WELL

someone who is **injured**, to avoid direct contact with sores, wounds, and body fluids **such** as blood, saliva, feces, urine, etc. Place anything that touched these body fluids in a plastic bag. Dispose of it where it won't **contaminate** other people.

Our homes have **many** building codes and safety devices to keep us safe. We **don't have** those outdoors, so you must be on the lookout for potential problems. For example, stay away from electrical wires, falling trees, and thin ice that can injure or kill you and your friends. Remind **others** how to use a knife and ax properly and how to respect and **care** for a fire. Injuries that cut off breathing or cause the loss of a lot of blood are life-threatening. Get your adult helper at once if there's an accident.

Let's get into it

Use a microscope to look at things that hide food poisons: mold, saliva, dirt on your hands, etc. What do you see happening? Are things moving? What do you think those things are? Work with your school or county office of the OSU Extension Service to find a microscope to use.

A petri dish is a small dish with a sterile nutrient-dense gel on which to grow bacteria. Rub the surface of a petri dish with a used dish cloth, a finger, or other object—or sneeze in it—to see what grows after a couple of days. Are several things growing in one dish? How do they look different—or the same? What does that mean? What else can you test? Throw out the medium and wash the dishes thoroughly in soap and water after your experiment.

It's good to have some first-aid training. Check with your local Red Cross or a parent who is a nurse or emergency medical technician (EMT) to teach you how best to treat cuts and burns. Talk with an EMT about his or her experiences in using first aid to keep a person from having more injuries or dying.

So what?

What are the important steps to keep food safe to eat? What are the extra challenges you have when cooking outdoors instead of in the kitchen? Talk with someone who has had food poisoning and have them describe how they felt and how long it took to get well. Describe a time when you were sick and you think now it might have been food poisoning. What food might have caused the food poisoning? How can you avoid food poisoning?

What are some important ways you can guard against cuts and burns? Research the best ways to care for these injuries.

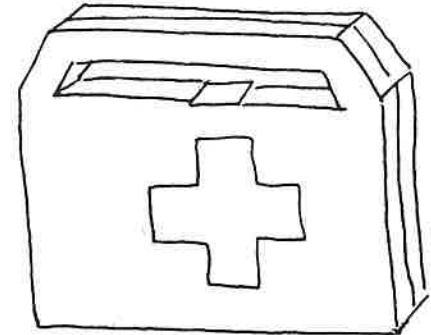
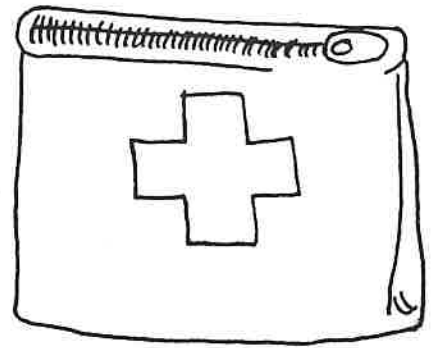

First-aid kits

Resources

USDA Food Safety and Inspection Service, SP 50-837, "Kitchen Cleanliness."

Food News for Consumers, USDA, Summer 1992.

Camping Made Easy, Michael Rutter, The Globe Pequot Press, Old Saybrook, CT, 1997.

The First Aid Book, Third Edition, SouthEast Alaska Regional Health Corporation, 1993.

Now what?

Check out this user-friendly Web site to learn more about food safety: www.fightbac.org

What steps do you need to take to be prepared to handle cuts and burns? Prepare a presentation on an injury that requires first aid.

Make a poster explaining the food-safety danger zone and ways to keep food out of the danger zone. Look at a variety of thermometers used to cook and store food. What temperature do hamburger, beef roast, and chicken need to reach to be safe?

Do a presentation on the different types of food poisoning.

Find out what is in a first-aid kit. Compare different kits. Why might they be different?

1C. Planning Party

Debera Tracy Schreiber, Extension 4-H agent, Wallowa County, Oregon State University

Here's what's important

It takes lots of planning to have a great outdoor event. Things to consider during your planning party are: Who will be going on this adventure? Where are you going? How are you getting there? How long will you be gone? What will the weather be like? How will you cook food there? What equipment will you need to cook and keep food safe? How much money will it cost?

Let's get into it

Organize a planning party! You and your friends, plus your adult helper, are the planning team. All will be sharing responsibilities. Sharing jobs makes the event more meaningful and fun for everyone.

- Invite everyone to a Planning Party.
- Decide where you want to go.
- Plan meals that everyone likes.
- Decide who is responsible for each job.
- Find chaperones and transportation.
- Record what helped and worked and what didn't.

On a large piece of paper, record every idea—whether or not you think it's good and/or workable. Start with where you want to go and let each person contribute an idea or two. Once you have everyone's ideas, go back and select (by voting?) a few that are the "best" or most realistic. Save all the extra ideas for the future. Check with your helper to make sure your choice is going to work. Do this again for meals and jobs to be done and who will do them. Check out the planning chart on the next page. It includes jobs that might need to be done. Who will do each job?

There's more

Create a planning chart each time you plan an outdoor cooking event, listing names, time and place of event, responsibilities, and due dates. Start a "memory book" of all of your outdoor cooking events—especially those where you go away from home and have a variety of adventures. Include your planning charts, menus, a map, photos, craft/activity items, and other memorabilia. Watch it grow as the years go by.

Life skills

- Finding, understanding, and using information
- Problem-solving and decision-making skills
- Communicating and relating to others

Goals

- Develop a plan and keep records of an event
- Assign responsibilities to all members and support each other

Supplies needed

- Big sheets of paper and markers
- Notebook to keep results of planning

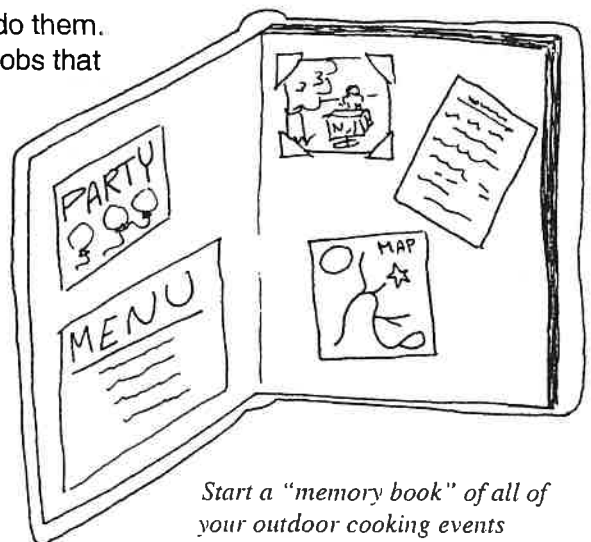

Start a "memory book" of all of your outdoor cooking events

1C. PLANNING PARTY

Planning chart

Date of event: _____ Destination: _____

Length of event: _____

Persons participating: _____

Overall chair: _____

Make arrangements for a place to go and get information back to the group. Make sure all chairpersons complete their assignments. If some chairs have difficulties, counsel and assist them.

Activities chair: _____

Plan all activities for the trip. Have ideas for recreation time or plan some fun learning activities. Work with equipment chair to make sure needed equipment is there.

Menu chair: _____

Take suggestions from the group to develop a menu for the event. Make a grocery list and work with the treasurer to purchase food. Work with equipment chair to make sure cooking equipment and supplies are on hand.

Equipment chair: _____

Work with all committees to make sure equipment for cooking and activities is available. Assign people to bring equipment.

Meal chair: _____

Organize a schedule to involve everyone in meal duties. People are needed to prepare the meals, wash dishes after the meal, clean the area, and take care of leftovers. Work with the cooking fire committee to make sure the fire is ready, if you are cooking on it.

Cooking fire chair: _____

If a cooking fire is needed, locate the site. Supervise wood collection or use charcoal, start and oversee the fire with adult assistance, and extinguish it when it is no longer needed.

Recorder: _____

Keep notes on the trip and record suggestions for the next time you go.

Treasurer: _____

Record income and expenses. Pay all bills for the event and be responsible for the money.

Things to consider	Person in charge	Date completed	Cost
Reservations			
Transportation			
Chaperone			

So what?

How did your planning session go? What was the most difficult part of planning? Did everyone participate? How were everyone's ideas valued? Describe how everyone was given a job they could handle. What other jobs must be added that are unique to a particular adventure?

Resource

The Well Fed Backpacker, June Fleming, Vintage Books, New York, 1981.

Now what?

Evaluation is an important part of every experience. Evaluate what you could have done differently to make things better yet. Even if you haven't done the event yet, you can evaluate the planning you did. What will you do differently in the future? When you return from your adventure, ask yourself what you could have done at the planning stage to make the trip better yet.

1D. Let's Do Lunch

Miriam Lowrie, retired Extension 4-H agent, Oregon State University

Life skills

- Finding, understanding, and using information
- Making good use of your resources
- Staying healthy
- Problem solving and decision making

Goals

- Learn about safe packed and/or picnic lunches
- Make a sack lunch
- Make an insulated lunch bag—BONUS!

Supplies needed

- Three thermometers
- Your favorite sandwich supplies
- Fruits and vegetables
- Peelers
- Paring knife
- Plastic bags
- Sewing machine, fabrics, and notions for BONUS activity

Here's what's important

Picnics are fun for you and your whole family! Remember, some food spoils quickly when it's not refrigerated, so here are some tips to help you prepare safe and tasty picnics.

Pack your picnic lunch safely. Take only the amount of food you'll use. Start with cold food packed right from the refrigerator or freezer. Use an insulated cooler or lunch bag. Pack all food in clean plastic wrap or sandwich keepers/bags. Make simple sandwiches ahead and freeze them, individually wrapped, in larger plastic bags; they will thaw by lunchtime. Pack lettuce, tomato, and mayonnaise in separate containers; add them just before eating. Pack relishes in separate bags.

Include a cold source in the cooler or picnic basket, such as commercial ice packs. Make your own by freezing small cans or boxes of juice, yogurt, or applesauce, or by placing ice cubes in a plastic bag and then wrapping the bag in foil. With a good cooler and ice, most foods are safe for short periods of time.

Keep hot foods in an insulated, tightly sealed food or beverage container for no more than 2 to 3 hours. Don't include any partially cooked foods. Foods cooked at home must be chilled thoroughly in small batches before taking to a picnic. Pack heavy foods first and light things that may get squished, last.

If you do not have insulated carriers, take fresh, canned, or dried fruits; raw vegetables; hard cheese; canned or dried meats or fish; dry cereal; bread; peanut butter; crackers or cookies.

Perishable foods should be thrown away if they have been in the danger zone (40 to 140°F) for more than 2 to 3 hours. Remember, food spoils more quickly in summer heat. If you can't eat everything in your lunch, save the nonperishable foods for later, like cookies, candy bar, whole apples, oranges, chips, and nuts.

When you prepare to eat at the site, wash your hands and the area you'll be using to prepare foods. Keep food cold until you're ready to eat it. Cover food to keep out insects, bacteria, and dust. When you're done eating, store leftovers right away. When in doubt, throw it out!

Let's get into it

Keep a cooler cool

When you take food in a cooler, keep it in the shade. Don't leave it in direct sunlight or in the trunk of the car. Here's an experiment:

1D. LET'S DO LUNCH

Place one thermometer under a shady tree, one on a picnic table, and one in the trunk of your car. After 5 minutes, read the temperature to see which place would be best to keep your cooler to help keep food safe. Keep the cooler lid on tight, avoid frequent openings, and serve quickly from the cooler. Add more ice if it begins to melt. Serve small portions from the cooler so the food doesn't stay out of the cooler too long.

Plan a hike and take your lunch. Plan a filling, nutritious lunch that is easy to carry and keeps well. Remember, fresh foods spoil more quickly if it's hot outdoors, so pack your foods safely. Be sure to carry a good supply of drinking water with you.

Sandwiches are quick and easy to fix and serve. You'll need your favorite bread—sliced, pita, rolls, English muffins. Spread with your favorite topping—butter, mayonnaise, mustard—or make the spread the filling, like peanut butter, jam, or honey. Try peanut butter with bananas, pickles, or marshmallow cream—one of them might become your favorite! Sandwich fillings can be cheese, sliced or chopped cooked meats, or other thinly sliced or spread meats. Remember, foods containing protein spoil easily. Keep protein sandwich fillings cold until ready to eat. Mayonnaise and salad dressings contain eggs and also must be kept cool. Cool leftovers right away!

Raw fruits and vegetables make great hiking snacks. These crunchy foods help keep teeth and gums in good condition. Most are full of vitamins and water. Wash all fruit and vegetables thoroughly. For root vegetables, use a vegetable peeler and peel away from you. Don't break the skin on delicate tomatoes. To cut or slice vegetables, hold them firmly and always cut down onto a cutting board. Place them in a plastic container or bag to chill. Try a fruit and vegetable sandwich: pita bread filled with apple slices, walnut pieces, grated cheese, and sliced lettuce!

There's more

It's a BONUS project! Let's make an insulated lunch bag to carry your lunch! (If you're unfamiliar with using a sewing machine, ask your adult helper for assistance.)

Fabric and notions needed to make an insulated lunch bag

- Two pieces of 16- by 12-inch sturdy cotton fabric (such as denim or canvas) for the outside
- Two pieces of 16- by 12-inch cotton or ripstop nylon that will look good inside the bag

When you take food in a cooler, keep it in the shade...



...not in direct sunlight...



...or in the trunk of the car.



1D. LET'S DO LUNCH

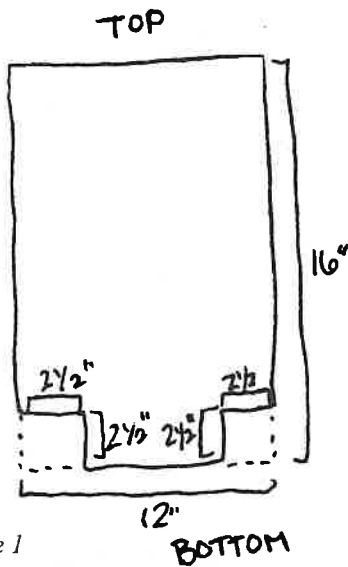

Figure 1

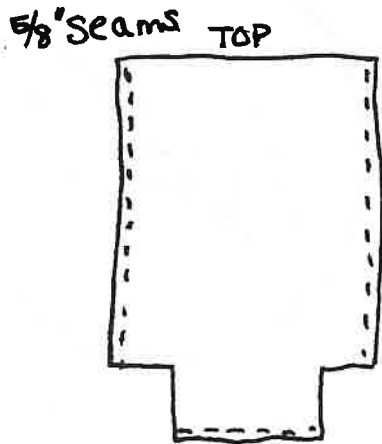

Figure 2

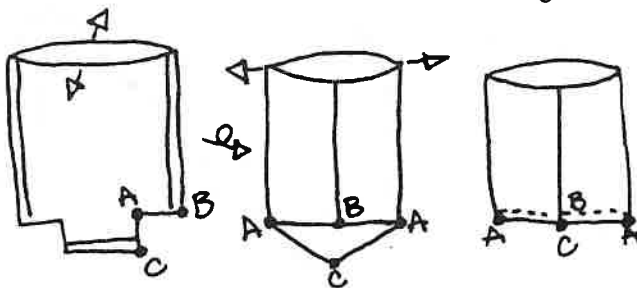

Figure 3

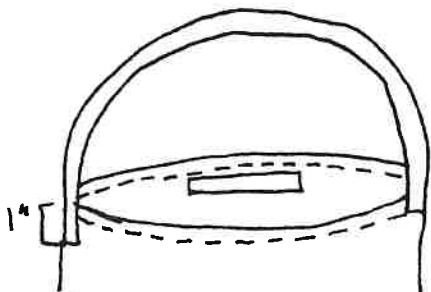

Figure 4

- Two pieces of cotton batting 16 by 12 inches ("Warm Window" insulated lining is great)
 - A 5-inch length of hook-and-loop fastener tape (like Velcro®), ½ inch wide
 - A 20-inch piece of sturdy, 1-inch-wide braid for a handle
 - Sewing machine and supplies
- Lay all of your fabrics in a stack and cut a 2½-inch square from both of the bottom corners on the 12-inch side (Figure 1).
 - Lay one batting fabric on the table and place the outside fabrics over it, right sides together. Place the other batting fabric on top. Pin the fabrics together. Stitch a ⅝-inch seam down one long side, across the bottom side, and up the other long side, securing the stitching at each end (Figure 2). Stitch the two pieces of lining fabric together in the same way, right sides together.
 - To form the bottom of the lunch bag, pull the middle of each side of the bag out (hold the two fabrics together on each side, matching the cutting lines on the bottom sides and B & C) and stitch the open edges together in a ⅝-inch seam (Figure 3). Repeat for the other side of the bag and the lining section.
 - Turn the insulated bag right side out. Pull the lining over the insulated bag, the right sides together; match top edges. Pin them together and stitch around the top ¾ inch from the edge, leaving an opening about 3 inches long. Pull the bag through the opening so it is right side out and no raw edges show. Carefully pin the finished edge together so it's flat, and slip stitch the 3-inch opening closed, catching in the batting. Use long hand stitches to baste this finished top edge together about ½ inch from the edge so it stays smooth for the next steps (Figure 4).

- Press under the raw edges of the braid handle so it will not ravel out. Pin it to the side seams of the bag about 1 inch from the top on the outside. Pin the hook and loop tape to the front and back of the inside of the bag about ½ inch from the top (Figure 4).

- From the inside, stitch the top edge of your bag all the way around, stitching on the bottom of the first strip of hook and loop tape. As you go around the side, stitch the bottom of the first end of the handle on the outside of the bag. Continue stitching the opposite piece of the tape across from the first, and, finally, the other end of the handle. Now stitch one more time around, catching the top of the tapes and over the handle ends for extra strength. Take out the basting thread.

WOW! You've made an insulated lunch bag! Use it for picnics or school, throw it in the washing machine and dryer, and know that you're helping our environment by not throwing away bags after

1D. LET'S DO LUNCH

every lunch!

So what?

How do you keep your food safe when you take it away from home to eat later? Did your picnic lunch have foods from all the food groups in the pyramid? What could you add to make your meal better? What's your favorite sandwich?

What did you like about working on the sewing machine? What was the hardest part of making the insulated lunch bag? What other projects would you like to make for your outdoor cooking adventures?

Now what?

Many bring their lunch to work or school every day. How many paper and/or plastic bags would they save a month by using insulated lunch bags, a plastic sandwich saver, and/or snack containers?

How many of your friends make their own lunch for school? If you need a gift for them, make them an insulated lunch bag! Pick fabrics that are their favorite colors. If you want to make one that keeps leaks from coming through, use a vinyl-coated fabric for the lining.

Footnote facts

John Montagu, 4th Earl of Sandwich (1717–92), liked his roast beef between bread slices; that's how the sandwich got its name.

The five most popular sandwiches are ham; ham and cheese; tuna salad; bacon, lettuce, and tomato; and peanut butter and jelly. Which four need to be refrigerated?

Resources

School-Age Connections, Carole Eller, University of Connecticut Extension Service.

"Safe Food for Potlucks and Picnics," Oregon FCE Lesson, Jan. 1998, by Janice Gregg, OSU Extension agent; Nona Hoadley, volunteer; and Carolyn Raab, OSU Extension Food & Nutrition specialist.

Chapter 2—Nutritious Meals and Snacks

2A. Good Food that Stays Good

Renee Carr, OFNP, Multnomah County Extension, Oregon State University

Life skills

- Finding, understanding, and using information
- Staying healthy and in good physical condition, and refining coordination

Goals

- Use the Food Guide Pyramid as a guide for making healthy food choices
- Practice making food choices for lifelong good health and endurance
- Keep food safe: Keep It Clean, Cook It Well, Cool It Soon
- Make a model of a Gastrointestinal (GI) Tract

Supplies needed

- Food pictures
- Blank Food Guide Pyramid
- Two brown sacks
- Cardboard
- Empty, 1-liter plastic soda bottle
- 32 feet of lightweight rope
- Marker/tape
- Index cards
- Paper

Here's what's important

Healthy eating is like a puzzle with many parts. Each part is different. It's a matter of balancing choices from each of the five food groups as you plan each meal. To get all the pieces in the puzzle, try the following:

- Balance your food choices. Balance means choosing the right amount of foods from all the five food groups daily to give your body enough calories and nutrients. (Nutrients are obtained from the food you eat and give you fuel to keep going!)
- Include variety in your foods at each meal. Variety is picking food from each of the five food groups. Your body gets nutrients from eating a variety of foods. Eat more fiber foods such as whole grains, fruit, and vegetables. These give you nutrients and energy. Have fun trying new foods!
- Eat in moderation. Control the number of calories and especially the total amounts of fats, salt, and sugar.
- Eat smart! When you plan a meal, remember balance, variety, and moderation and you'll be a nutrition winner!

Let's get into it

Play a relay game by placing food in the correct section of the pyramid. Cut out some pictures from magazines representing all food groups. Place the pictures in two brown sacks with an equal number in each sack. Divide into two teams and have each team place the foods on the pyramid as quickly as possible. When completed, check to see if you placed all of the foods in the right place according to the Food Pyramid Chart.

Vegetable and fruit scattergory

Think of fruits and vegetables for each letter of the alphabet. Some letters have many choices! Set a time limit. Write down all the fruits and vegetables you can think of for each letter of the alphabet. WOW! All of these choices, plus whole grains, will help you get the fiber-rich foods you need to keep your food moving through your gastrointestinal (GI) tract (stomach and intestines) to stay healthy.

Deeper we go

Food as fuel: Endurance is the ability to sustain an effort/activity for a long time. Peak endurance improves by eating a diet high in complex carbohydrates. Complex carbohydrates are starches and fiber,

2A. GOOD FOOD THAT STAYS GOOD

and are found in grain-based foods, vegetables, and fruits. Starch and fiber are absorbed into the system more slowly. The body travels extra miles on this fuel mixture.

Simple carbohydrates are sugars (like those found in candy, pop, and juice.) They are absorbed into the digestive system very quickly. The body travels only a short distance on this fuel mixture.

Endurance requires eating a variety of food that provides long-burning energy. Complex carbohydrates provide the body its preferred fuel mix and can triple endurance.

There's more

Remember to Keep Food Safe: Keep It Clean! Cook It Well! Cool It Soon! You learned the basics in Chapter 1B, "Keep Healthy and Well." Getting sick is no fun. Most "24-hour flu" is a foodborne illness. Symptoms of foodborne illness include nausea, diarrhea, and stomach cramps. Bacteria, commonly called "germs," cause foodborne illness. Germs are everywhere on hands, hair, pets, insects, and in the air. Germs are spread by coughing, sneezing, and touching. You will prevent foodborne illness and keep food safe if you keep your hands, cooking surfaces, and utensils clean; cook foods thoroughly; and cool foods quickly. Remember also to rinse soap thoroughly off all dishes to prevent an upset stomach.

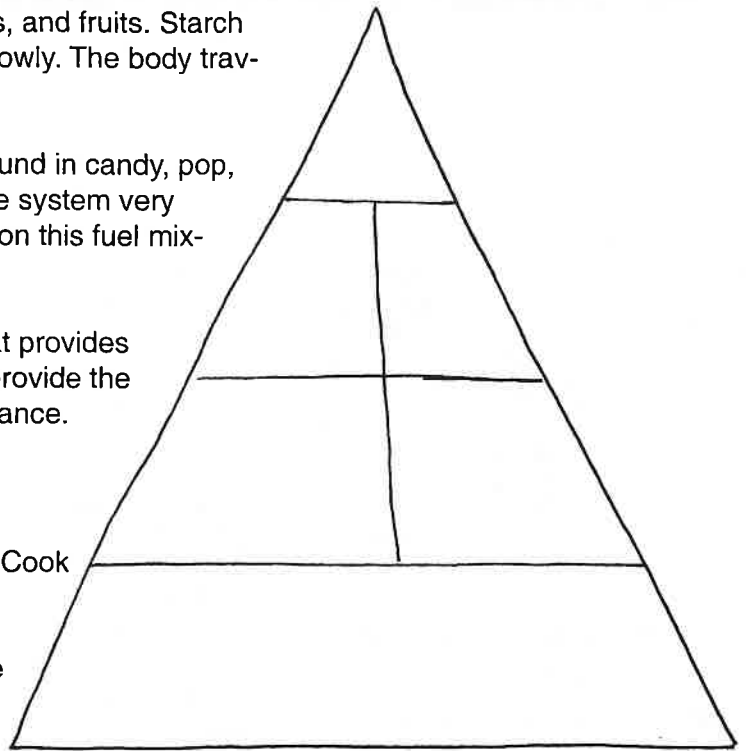

Play a relay game by placing food in the correct section of the pyramid.

Let's get into it

Cool It Soon Relay: Bacteria like to grow on perishable foods—foods that spoil quickly—when the temperature is warm. After 2 to 3 hours at room temperature, these foods will be unsafe to eat, so they must be kept cold to keep bacteria from growing.

The picnic is over and the ball game is ready to start. Which foods need to be put in the cooler to keep them safe to eat after the game? Write each food from the list below on an index card or piece of paper. Place each card or piece of paper in the cooler or on the table, whichever you think is better:

Banana, corn on the cob, bread, hard-cooked eggs, carrot sticks, French fries, cheddar cheese, fried chicken, cookies, ham, pasteurized fruit juice, hamburger, oranges, leftover spaghetti, peanut butter, pizza, potato chips, potato salad, pretzels, tuna casserole

Did you put the right foods in the right place? Every other food in the list goes in the cooler. Foods that are safe without refrigeration include raw whole fruits and vegetables, cheddar cheese, peanut butter and jelly, crackers, pretzels, and popcorn. Cool It Soon! If in doubt, throw it out!



Supplies needed to build a model of a GI (gastrointestinal) tract.

Write these facts on the index cards

- The esophagus is about 12 inches long. Food takes 1 to 7 seconds to travel from the lips through the esophagus to the stomach.
- The stomach is about 8 inches long. Food takes an average of 3 hours to move through the stomach, but it can take anywhere from 1 to 6 hours.
- The small intestine is about 20 to 25 feet long. Digested food takes 2 to 10 hours to travel through the length of the small intestine.
- The large intestine is about 5 feet long. Digested food takes about 13 hours to move through the large intestine, but can take up to 5 days.

Resource

Pyramid Power: Food Choices for Winners, EM 8715, OSU Extension Service, 1999.

Deeper we go

Build a model of a GI (gastrointestinal) tract to demonstrate how long food takes to travel through you. You'll need red cardboard lips, a 1-liter plastic soda bottle, 32 feet of lightweight rope, tape or a marker, and four index cards. Connect the lips to the top of a 1-foot section of rope (the esophagus). Attach the bottom of the rope to the cap area of the bottle (the stomach). Make a small hole in the bottom of the bottle, thread the remaining rope up through the bottle and knot it. Pull it back down and you've got intestines! The first 25 feet is the small intestines. Using tape or the marker, color the last 5-foot section (the large intestine).

So what?

What does the Food Guide Pyramid mean to you? Why are there different food groups on the Pyramid? How much do you need of each? Which food groups will give you the best endurance for strenuous activities? What does food safety mean to you? When and for how long do you need to wash your hands for them to be safe to handle food? How does cooking foods thoroughly keep your food safe? What are perishable foods and how should you store them? What do you do with food if you doubt its safety? What happens to food as it goes through the GI tract? What happens when bad food goes through the GI tract?

Now what?

Keep a food diary. See how well you balance the amount of food, food choices from all five food groups, the variety of foods you eat, and the foods rich in fiber. Which foods do you need to eat in moderation? Which foods are especially needed for endurance?

Observe how your family keeps food safe: How do they keep it clean? How do they cook it well? How do they cool it soon? Talk with your family about what is best to do.

Research different bacteria that cause foodborne illness. How long does it take before you feel ill effects? How does this affect your GI tract and your nutritional well-being?

2B. Extraordinary Eats

Miriam Lowrie, retired Extension 4-H agent, Oregon State University

Here's what's important

The wise outdoor cook chooses meals that are simple to prepare, interesting, well balanced, and full of nutritious food. The outdoor cook should be well organized with ingredients and supplies needed on hand; practice safety around hot fires, pans, and sharp tools; prepare foods cleanly and safely; keep hot foods hot and cold foods cold; involve everyone; and leave a clean camping area.

There are three types of outdoor meals:

- 1) All of the food is prepared in the home, packed, and carried to the outdoors.
- 2) All of the food is prepared outdoors, some over a fire.
- 3) A combination of these—part of the food is prepared in the home and part is cooked over a fire outdoors. Do not transport partially cooked meat or other protein foods. They should be transported either frozen raw or frozen fully cooked.

Remember, you will be hungry for outdoor meals, so plan plenty of food. Keep a variety of colors, temperatures, textures (soft and crisp), and flavors in mind as you plan and serve meals attractively.

Let's get into it

Here are some foods that pack well.

Breakfast

Granola	Chunky cereals	English muffins
Toaster pastries	Jerky	Dried fruits
Pancake mix	Powdered milk	Melons
Hot cocoa mix	Dried hashbrowns	Dried bacon bits

Lunch

Bread	Cheese	Meat sticks
Jerky	Peanut butter	Instant pudding
Powdered drink mixes	Instant soups	Canned meat/fish
Apples and oranges	Carrots and celery	Onions

Dinner

Instant potatoes	Rice	Macaroni and cheese
Canned meat/fish	Prepared baking mix	Cornbread mix
Popcorn	Dry gravy mix	Spaghetti
Hamburger meal mix (with frozen hamburger)	Instant sauce mix	

What other foods are easy to pack? How heavy are they and how must they be stored? Some foods must be kept cool in order to be safe. Make a list of foods you like that are easy to pack and make.

Life skills

- Finding, understanding, and using information
- Staying healthy
- Problem solving and decision making

Goals

- Learn foods that are easy to prepare outdoors
- Start a sturdy recipe file for outdoor use

Supplies needed

- Index cards
- Clear self-adhesive paper or laminating machine
- 2-inch locking ring



Here are some quick and easy meals for cooking outdoors—all you add is water! Try them in your kitchen first and then adapt them for outdoor cooking adventures.

- Japanese noodle mix, salami bits, and dried, mixed vegetables
- Macaroni and cheese, canned tuna, dried vegetables
- Dried potatoes au gratin mix, dried green beans, canned tuna
- Quick rice mix, dried peas, canned ham/Spam®, cheese sauce mix
- Quick rice mix, canned chicken, cream of chicken dried soup, dried onions, cheese topping
- Instant cooked cereal, raisins, dried milk, sugar
- Quick rice, raisins or dried apricots, sugar, cinnamon, and dry milk

As an outdoor cook, you won't have a fully equipped kitchen available—including refrigerator/freezer, blender, microwave, etc.—so plan foods that don't require these. For example, setting gelatin requires a refrigerator, so it's not a good choice for outdoor meals. A refrigerator is necessary to keep meat out of the danger zone (40 to 140°F) for a long period of time. Insects are attracted to sticky, sweet, and many other foods; prepare and eat your meals quickly and clean up carefully to help keep them away. What other foods might cause food safety or food quality problems?

There's more

Start an outdoor cooking recipe file to take on your adventures. Every time you go to an outdoor meal, try to get one new recipe that tasted good to you. Bring paper and pencil to write down as much information as you can gather. If you can get the real recipe, great! When you get home, recopy your recipe on an index card to fit in your collection, write neatly, and include all the important facts. Recipes usually are written like this:

- Name of recipe
- Who gave it to you/where you got it
- Number of servings
- Amount of each ingredient needed
- Steps in preparation
- Steps in cooking—especially: method (bake, broil, fry, etc.), time and temperature (approximate if cooked outdoors), and how to serve the food (garnishes, toppings, etc.)
- How to store leftovers

Start an outdoor cooking recipe file to take on your adventures.

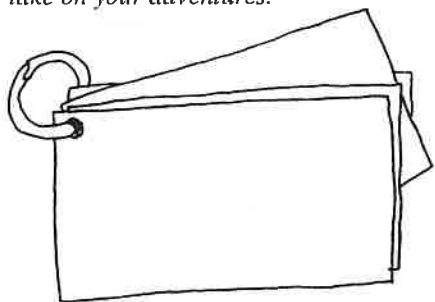

When you've completed your recipe card, cover it with clear self-adhesive paper (such as Contact® paper) or laminate it to keep it clean while you are using it—especially in the out-of-doors. To finish your recipe collection, punch a small hole in one corner and put all your recipes on a locking ring so you don't lose any of them. Keep

your recipe file with your camping gear.

Deeper we go

More and more “easy-to prepare” foods are developed every day. Check the shelves in your favorite grocery store and find foods that are lightweight (usually they are dried and you need to add water) and can be mixed with other dried foods to make a complete meal. You’ll also be able to find these foods at “outdoor” stores. Which store has the best variety to choose from? For one of your favorite foods, compare prices, taste, and how easy it is to prepare. Where can you find the best buy?

Try some new combinations, and start to develop your own recipes for great outdoor foods. Using the Food Pyramid, select 2 cups cooked grain product, 1 cup cooked vegetables, 1 cup cooked protein serving, and 1 cup sauce to keep it all together. Add a few seasonings ($\frac{1}{2}$ tsp each or so) and heat in a moderate (350°F) oven for about $\frac{1}{2}$ hour.

This serves four people. Be creative and try some different combinations!

For one of your favorite foods, compare prices, taste, and how easy it is to prepare.

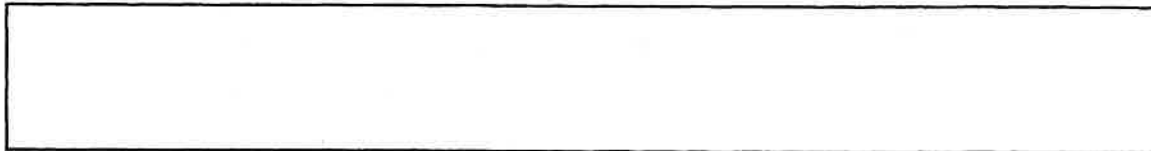

So what?

What are your favorite easy-to-fix foods? What favorite recipes does your family have that can be adapted for outdoor cooking? What combination of foods that you created tasted best to you? Where else can you find new recipes to add to your collection?

Now what?

Note foods that are served at outdoor activities. Which were prepared totally indoors and brought outdoors? How are they kept cold or hot to keep them safe? Are any of them prepared out-of-doors? What steps were taken to ensure food safety? Were there a variety of colors, temperatures, textures, and flavors? Which tasted best to you? Who prepared that food? Ask them what they did to make it especially good. Do they have a special recipe to share?

2C. Incredible Edibles

Cheri Jo Carter, Extension agent, Union County, Oregon State University

Life skills

- Problem solving and decision making
- Finding, understanding, and using information
- Making good use of your resources
- Staying healthy and in good physical condition, and refining coordination

Goals

- Make quick, nutritious meals and snacks without cooking

Supplies needed

- Self-sealing bags
- Waxed paper and/or clear wrap
- Liquid and dry measuring cups and spoons
- Ingredients you choose for the recipes you select

Here's what's important

In the outdoors, it's good to have food that doesn't require cooking. Perhaps your adventure ends up being a little longer than planned, fire danger is too high to build a cooking fire, or something else comes up that prohibits you from cooking. Plan to have some of these, or your favorite, no-cook items with you.

No-cook breakfast ideas

- Jerky, fruit leather, cheese rice cakes
- Breakfast bars, juice, peanut butter on apple slices
- Granola mixed in yogurt; orange slices

No-cook lunch ideas

- Crackers and cheese spread, apple slices, baby carrots
- Peanut butter and banana sandwich, fruity yogurt bar, broccoli flowers
- Cream cheese, sunflower seeds, and jelly on English muffins; dried apricots

No-cook dinner ideas

- Canned tuna, mixed dried fruit, bagel and cream cheese
- Cheese, apples, and walnuts in pita bread; carrot coins, cookie
- Dried beef spread with cream cheese, rolled around a bread stick (or a sweet pickle!), dried banana chips

Let's get into it

Brainstorm ideas for "no-cook" meals with your friends and adult helper. Remember, brainstorming means writing down every idea, and all ideas are welcome! Think of all the foods you have at home that you don't have to cook. Make sure they don't require extended refrigeration and that they are easy to transport. What combination of no-cook foods would taste good to you? Plan a day's menu that doesn't require any cooking and would be tasty. Use the Food Guide Pyramid to make sure you're getting all the food groups you need each day. Practice making these meals before you go on your adventure.

Write down all your favorite snacks and share with each other a favorite snack that could be eaten while you're out and about. Write your ideas on a recipe card to save for the future. Choose the best ideas as a group for your first adventure.

Remember to wash your hands before you prepare or eat any food.

2C. INCREDIBLE EDIBLES

Sing the “Happy Birthday” song while you wash your hands, to make sure you wash long enough to kill germs.

Make a “trail mix”

You can buy “trail mixes” already put together. Take pencil and paper to the grocery store and “price” some pre-made trail mixes.

- Write down the size of the bag (pounds or ounces).
- Read the nutrition label—find out how many servings are in the bag and how big a serving is.
- List what is in the trail mix; for example, nuts, dried fruit.
- What is the cost of the trail mix? Figure out the cost per serving.

Buy the same ingredients you saw in the “ready-made” trail mixes to create your own. Don’t forget to buy self-sealing bags to package your mix or create your own package. Figure out the cost of your ingredients and packaging. How many servings did you make?

Trail mix ingredients can be anything that does not require refrigeration and is easy to eat. Remember to use nutritious ingredients. You want energy from your snack, not a sugar high, because you will do a lot of physical activity while out and about. Possible ingredients for your trail mix might be seeds, nuts (almonds, hazelnuts, peanuts), dried fruit (raisins, apricots, dates), coconut flakes, M&Ms®, small crackers, or chunky cereals. What are your ideas?

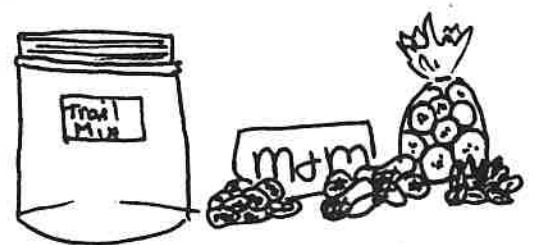

Make your own trail mix.

There's more

Try these hearty, make-at-home snacks to take on outdoor adventures—adapt them to your individual taste.

G.O.R.P. (“Good Ole Raisins and Peanuts”)

- 1 small box raisins
- 1 package salted peanuts
- 1 package M&M® candies

Mix all together. Put in a resealable plastic bag for easy carrying.

Baked G.O.R.P.

- 1 can sweetened condensed milk
- 1 cup chocolate chips
- 1 cup raisins
- 1 cup coconut
- 1 cup nuts
- 2 cups oatmeal (not instant)

Mix together well. Press onto greased baking pan. Bake at 250°F until lightly browned—approximately 30 minutes. Let cool. Cut into chunks. Put in resealable plastic bag.

- Breakfast cookies
- ½ cup shortening
- 1 cup brown sugar



2 eggs
 1 Tbsp milk
 1 tsp vanilla
 ½ tsp soda
 ½ tsp salt
 1½ cups flour
 2 cups granola mix

Lightly grease baking sheets. Cream together shortening and brown sugar. Add eggs, milk, and vanilla. Beat well. Sift flour, soda, and salt together. Add to sugar mixture. Stir in granola. Drop by spoonfuls onto baking sheet. Bake in 350°F oven for 10 to 12 minutes or until edges are browned. Makes about 3 dozen cookies.

Unbaked oatmeal cookies

Mix together in pan and boil for 1 minute:

2 cups sugar
 ½ cup milk
 ½ cup butter or margarine

Add and mix in thoroughly:

3 cups quick-cooking oatmeal
 ½ cup nuts or raisins
 3 Tbsp cocoa or peanut butter
 1 tsp vanilla

Drop on waxed paper and let set until firm. Wrap individually in clear wrap.

Deeper we go

Snacks are important, especially in the winter when your body needs more calories to keep warm. High-calorie foods such as dried fruits, nuts, cheese, dried meat, and chocolate are best for snacks. They provide energy to give you extra “get up and go.”

The name “G.O.R.P.” has been given to trail mixes. Where did the word come from? Can it be any mix of ingredients in a handy snack? What kind of snacks do you think people who climb Mt. Everest eat? How often do they need to eat to keep up their strength in these extreme conditions?

So what?

Why is it important to plan some no-cook meals and snacks? What no-cook meals or snacks of your own did you invent? How many of the food groups did you include? Name them.

Now what?

Be prepared for unusual situations—especially when you’re in the great outdoors. Determination—and maybe some extra snacks—helps those who have gotten separated from their friends to sur-

2C. INCREDIBLE EDIBLES

vive. Read a book or article about a young person who survived being alone for a time. What did they do to keep going?

2D. Me and My Buddy

Edna Moon, 4-H leader, Polk County, Oregon

Life skills

- Finding, understanding, and using information
- Making good use of your resources

Goals

- Make a "Buddy Burner" and a "Tin Can Stove"
- Learn how to do this method of outdoor cooking

Supplies needed

For the Buddy Burner:

- One tuna fish can
- Corrugated cardboard
- Scissors
- Cloth or a small candle
- One #16 nail
- Old candle wax (which doesn't make as hot a Buddy Burner as paraffin) or 1 stick paraffin
- Matches
- Pot holder

For the Tin Can Stove:

- One #10 (large) coffee can
- Bottle opener
- Tin snips
- Pliers
- Can opener
- Pointed can opener

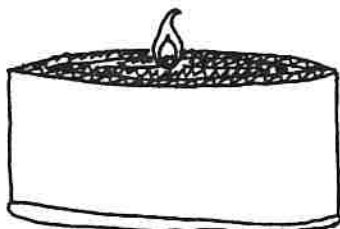

Figure 1

Here's what's important

A Tin Can Stove with a Buddy Burner is one of the most fun and useful pieces of outdoor cooking equipment you can make. They are great to cook breakfast or a hot drink outdoors and will allow you to have something hot at home when the power fails. It takes little space to store two or three Buddy Burners and a Tin Can Stove.

You can use these stoves almost anywhere. Be sure the ground is level and free of dried grass, leaves, or other dried materials. You might set your Stove and Buddy Burner on gravel, bricks, or cement so it won't burn a circle in the ground. The Buddy Burner and Tin Can Stove are hot when in use; don't touch them with your hands. Always use a potholder. Do not cook on top of a picnic table, as the heat will leave black circles on the table. A stick match is great for lighting Buddy Burners.

Let's get into it

Building a Buddy Burner

1. Measure the height of a clean, empty tuna can.
2. Cut strips of corrugated cardboard the same height as the can.
3. Start wrapping cardboard tightly around the nail. Hold cardboard tightly as you add another layer. Continue until it fits into the can snugly. It doesn't have to be wrapped evenly, but you get a longer burning time if it is. Put the roll of corrugated cardboard in the tuna can.
4. Place the tuna can on several sheets of newspaper to prevent a mess.
5. Melt wax in a tall can that is set in a pan of water. A 46-oz juice can works well (it's tall, so you won't have to touch the can where the hot wax is; you can bend a spout for easy pouring; and wax won't get in your good pans). It has room to melt enough wax for two to three Buddy Burners.
6. Pour melted wax over the top of the corrugated cardboard, slowly letting it settle into cardboard holes. Don't let it puddle on top. When the holes are filled, you're done!
7. When the wax is almost cool, work the nail out and replace it with a birthday candle that is about $\frac{1}{2}$ inch higher than the cardboard in the can. Your Buddy Burner is complete! (Figure 1)

To control the amount of heat from the Buddy Burner, make a temperature regulator (damper) (Figure 2). Use the lid from the tuna can. Using the nail, punch two small holes near one edge of

2D. ME AND MY BUDDY

the lid. Secure a 10-inch piece of wire through the lid holes. Wrap with masking tape on the end of the handle for safety. For low heat, cover $\frac{2}{3}$ of the Buddy Burner with the lid. For medium heat, cover $\frac{1}{3}$ of the can. Heat is regulated through the door of the Tin Can Stove (Figure 3).



Figure 2

Building a Tin Can Stove

Model 1—The “Cook on Top of the Stove” Model

1. Clean and remove all labels from a #10 can (large coffee can size) that has one end removed.
2. With tin snips, make a 3-inch-long cut in from the open end of the can.
3. Two and one-half ($2\frac{1}{2}$) inches over from the first cut, make another 3-inch-long cut in from the open end of the can.
4. Leaving a $\frac{1}{4}$ -inch edge, cut out that $2\frac{1}{2}$ - by 3-inch section. Carefully roll in a $\frac{1}{4}$ -inch edge with the pliers on the three cut edges and squeeze back the edge tightly.
5. At the top of the can and on the opposite side from the doorway, make three openings on the side of the can with the pointed can opener (Figure 4).
6. Place the Tin Can Stove over the Buddy Burner. Light the burner, and cook your food on the top of the can.

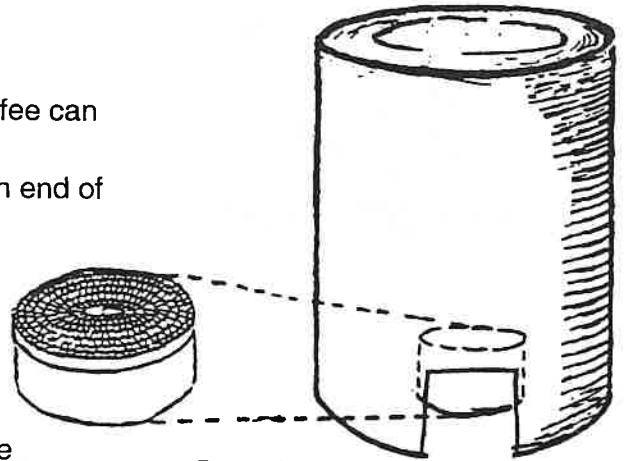

Figure 3

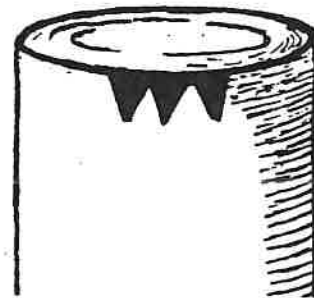

Figure 4

Model 2—The “Chimney to Hold the Pan” Model

1. Do steps 1–4 in the same way as Model 1.
2. Cut out the other end of the can. Now, using the pointed can opener, make three openings on the side of the can (Figure 5).
3. Place a small frying pan over the top—the heat from the Buddy Burner will cook the food in the pan.

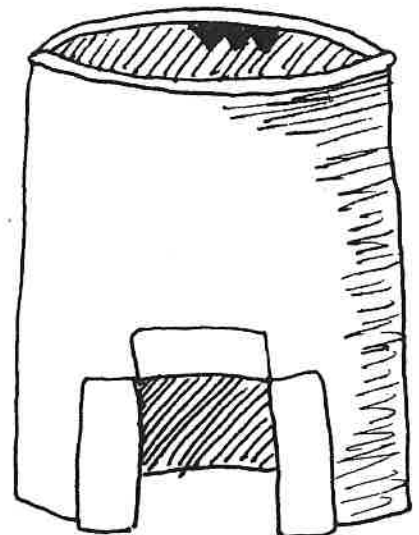

Figure 5

There's more

To put out the fire in your Buddy Burner, use a potholder to turn your Tin Can Stove over. Place it on top of the Buddy Burner. Be sure there is no grease or food on top of the Tin Can Stove. This will cut off the oxygen to your little fire and put it out. Never use water.

Remember: When cleaning your outdoor cooking equipment, don't leave soap on any cooking surface.

Now let's cook!

Buddy breakfast



1 slice bacon—cut in thirds

1 egg

Pancake batter

On the top of the stove, fry your three little slices of bacon. Remove bacon to a plate, then fry your egg until well done. Remove to a plate, then add batter for one pancake. Cook, flip when the bubbles cover the pancake, and cook completely. Now it's time for your buddy to make his or her breakfast on the Tin Can Stove.

Buddy steak

1 3-ounce steak

1 tsp butter

Barbecue sauce (if desired)

Melt the butter on the top of the can. Add steak; cook until meat and juices are brown. Turn with tongs. If needed, lay a piece of foil loosely over the top. Barbecue sauce may be added at the end.

Gingerbread for buddies

Gingerbread mix

Mix the batter according to directions and pour into a clean, greased tuna can about $\frac{2}{3}$ full. Place on top of the Tin Can Stove, covering it with another can that is a bit larger than the tuna can to form a mini "oven." Bake for about half of the suggested time. Using a large potholder, remove the "oven" can and check it. Stick a toothpick into the middle of the cake and pull it out. If it's clean, the cake is done. Replace the "oven" can if it still needs more baking time. Cool and eat. Always use potholders when working around the tin can stove while it is hot.

Deeper we go

See how long you can make a Buddy Burner last. With a permanent marker, write the year you first made it on the side of the can. When you're done cooking, if you've used a lot of wax, melt more and refill your Buddy Burner. Remember to fill it slowly and fill only the holes in the corrugated cardboard—no puddles on top. Did you put a nail in for another small birthday candle? You'll need a wick, right?

So what?

What did you enjoy best about making your Buddy Burner and Tin Can Stove? What was the hardest part? What would you do differently on your next one? What was your favorite food to cook on the Tin Can Stove? How long did your Buddy Burner last?

Now what?

When would you most likely use your Buddy Burner and Tin Can Stove?

2D. ME AND MY BUDDY

As you look at pictures of people cooking around the world, notice whether Tin Can Stoves are used. Perhaps people who travel with their herds of animals, people who do not have ready access to electricity, or people who are refugees from their homes might use this technique for fixing hot food.

Adapt some of your favorite recipes for the Tin Can Stove. How do you have to use your temperature regulator (damper)?

If you have several friends who need to cook food as well, teach them how to make Tin Can Stoves and Buddy Burners and how to cook on them.

Chapter 3—Backyard Cookout

3A. Lay the Groundwork

Dana Martin, Extension 4-H agent, Crook County;

Elaine Husted, Extension 4-H agent, Grant County; and

R. Roy Hamilton, retired Extension 4-H agent, Oregon State University

Life skills

- Communicating and relating with others
- Problem solving and decision making

Goals

- Check for safe conditions before starting a fire
- Prepare your cooking fire area
- Make different types of fire starters
- Recognize good outdoor cooking equipment
- Know how to care for outdoor cooking equipment

Supplies needed

- Variety of outdoor cooking equipment, including pots and pans
- Variety of outdoor cooking utensils
- Supplies to make fire starters (household wax, egg carton, stick, pocketknife)
- Bucket of water
- Firefighting equipment

Here's what's important

In most camping areas, the location of your cooking fire will already be determined. Find the fire circle, a fire grate or pan, or the signs of a previous cooking fire to know where to put yours. Always restore your camping and cooking fire area to a natural condition before leaving. Your adult helper will help you determine where you should put your cooking fire.

You'll have a safe and successful cooking fire if you choose a spot where the fire is: 1) protected from wind; 2) close to water; 3) 15 feet away from trees, shrubs, and fallen or overhanging trees to protect them and their roots from heat; and 4) on ground cleared of leaves, grass, and sticks, down to solid dirt or sand in a 10-foot circle.

Safety checks

Check local weather conditions before building a fire. If it's too dry or windy, use a stove rather than building a cooking fire. Even a small spark can start a big fire! If conditions are good, collect all the materials you need to make your fire. Do not leave the fire once it is built. If there is a slight breeze, keep the wind to your back so your body can act as a shield when starting the fire. Be safe—don't build too large a fire. Build a fire just large enough to serve your cooking needs. Stop adding fuel before you're done cooking so fuel is not wasted.

Think about your clothing and hair when you're around a fire. Don't wear clothes that are light weight, loose fitting, ruffled, or hanging down—they might catch on fire. Tuck in your shirt and close your jacket. If you have long hair, tie it back so it doesn't get close to the fire. Some people tuck their hair into their jacket or shirt. Hair and light clothing will catch fire very easily, so don't let them get close to the fire.

Establish rules for being around a cooking fire. Examples of rules include:

- Have firefighting equipment on hand before you start
- Gather all fuel first
- Never leave the fire unattended
- No running or playing around the fire

3A. LAY THE GROUNDWORK

- Clean up the fire area completely before you leave

What other rules are important for your group to establish before you light a fire?

There's more

Outdoor cooking tools let you work a safe distance from the fire. The length of the utensils depends on the cooking method you're using—long-handled for bigger cooking fires and short-handled for Buddy Burners. Sturdy, long-handled metal tongs, fork, and spatula (with a wood insulator) are a basic set to have on hand. A long-handled basting brush is handy when putting sauce on meats. Potholders and oven mitts (or leather welder's gloves as your hands get bigger) will help protect your hands from the heat. A water spray bottle is handy to put out flare-ups.

Have metal handles on pots and pans, as plastic handles will melt and wooden ones might burn. Here's a trick: To make cleanup easier, coat the outside (sides and bottom) of aluminum and stainless steel pots and pans you use over fire with detergent/soap. If you use cast-iron pots and pans, clean them using water and a spatula only; don't use soap or scouring materials as they destroy the cast iron's "seasoning" (oils used to coat the pan for long-term use). Dry your cast-iron cookware by heating it in the fire so the water evaporates and doesn't cause rusting. Store your clean cooking equipment in one place together so it's ready to go for your next outdoor adventure.

Let's get into it

Gather a variety of pots and pans with different kinds of handles and coatings. Discuss which ones are best for using on a Buddy Burner, a grill, and/or a cooking fire. Which ones would your mom feel are acceptable for you to use in outdoor cooking? Where could you get pots, pans, and other utensils that would be used only for outdoor cooking?

Make a "Supply Basket" of extra dinnerware and silverware, napkins, and packets of condiments (salt, pepper, cream, sugar, ketchup, honey, etc.) for friends. Include moistened paper towels in self-seal bags to make cleanup a snap. Don't forget the can/bottle opener, matches, durable potholders, a meat thermometer, and a small, sturdy plastic container of bleach to sanitize dishes (write "bleach" on the top for safety). Remember to include serving plates and utensils. Plastic silverware, paper plates, and cups can be used, but be sure to dispose of them in the garbage can—not the fire. Styrofoam and plastics emit toxic fumes and plastic just melts; they don't burn like wood. Burning garbage (paper plates, wrappers, food scraps, etc.) will give off-flavors to the food that is cooked next on those coals. Keep your fire clean!

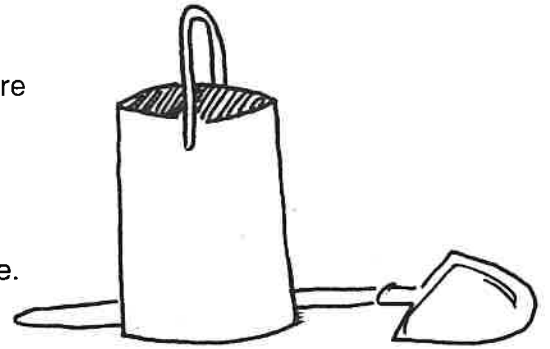

Have firefighting equipment on hand before you start



Outdoor cooking tools let you work a safe distance from the fire.

Deeper we go

Safety: Do this only with your adult helper. When melting paraffin wax for making fire starters, use one pan sitting in another pan partly filled with water (like a double boiler), so the wax will not ignite. Paraffin wax has a low combustion point—it flames and burns at a low temperature. Be cautious!



Figure 1.—Fuzzstick

Fire starters: You also can use fire starters to help get your fire going. Here are some ways to light a fire if you have little or no kindling.

- **Fuzzsticks:** Using a pocketknife, shave a 6-inch piece of wood (1 inch in diameter) again and again, away from you, without detaching the accumulating curls. When completed, this fuzzstick makes an excellent fire starter (Figure 1).
- **Egg cartons:** Separate the lid from the cardboard egg carton. Tear little pieces of the lid and put them in the bottom of the cups (or use sawdust or “dryer lint”). Tuck a small (used) birthday candle or a piece of heavy string in for a wick. Place the cups on newspaper. Pour melted paraffin into each eggcup until $\frac{1}{2}$ full. Cool. Cut the eggcups apart. Light one cup when you need a fire starter.

So what?

Why is it important to have water near your cooking spot? What could happen if you didn't check the weather conditions before building a fire? What happens if you don't use long-handled tools when cooking over a BBQ grill or fire? How is the cooking equipment for the Buddy Burner different from the equipment for the BBQ grill and cooking fire? How do you protect the “seasoning” of a cast-iron pan? What determines which cooking source—Buddy Burner, barbecue grill, or cooking fire—you use?

Now what?

In addition to a hardware or grocery store, where else can you find your “cooking tools”? Locate the safest place for your cooking source (Buddy Burner, barbecue grill, or cooking fire) in your backyard or campsite. Make an educational display on choosing a safe place for your outdoor cooking source. Show things to avoid as well as things to include. Give a presentation on the cooking tools you need for outdoor cooking. How do you make sure your “supply basket” is ready to go at a moment's notice after your outdoor cooking adventure?

Resources

The Outdoor Adventure Handbook, Hugh McManners, D.K. Publishing, New York, 1996.

Roughing It Easy, Dian Thomas, Dian Thomas Company, Holladay, Utah, 1994.

3B. Ready to Help

Elaine Husted, Extension 4-H agent, Grant County, Oregon State University

Here's what's important

When doing any type of outdoor cooking, do a safety check to prevent illness and accidents. If an accident occurs, knowing first-aid skills will help you help others. First aid is the care that is needed right after an accident has happened or somebody suddenly gets sick. Reduce the chances of an accident happening by thinking before acting—such as using a potholder so your hand or fingers don't get burned.

The Good Samaritan Act allows an untrained person to care for an injured person without worrying about legal liability. The Act is different for each state, but generally it protects you if a person needs immediate aid and you, the rescuer, do not intentionally harm the patient or act in a reckless manner. Ask the injured person if it is OK for you to help them.

If an accident does happen, first, and most important, remain calm and focus on the things you can do. Call an adult when an accident happens. If the accident is serious, call your emergency service number—911 in most cases.

Always have a first-aid kit on hand when doing any type of outdoor cooking or activity. For good up-to-date knowledge, get the latest version of the American Red Cross First Aid booklet to keep with your kit. Or better yet, take the basic first-aid class offered in your community. Here are simple guidelines for some of the first-aid problems you may come across. Use these as a guide only.

A person often goes into shock when an accident happens. Their skin feels cold, their breathing will be fast, and they may sweat or feel weak and nauseous. Always treat for shock when a serious injury occurs. Keep the person lying flat with legs slightly elevated, loosen the person's tight clothing, and keep the person warm and comfortable. Stay calm. Control the bleeding. Do not give food or drink. Call 911 or emergency services.

Cuts, abrasions, and scrapes

Your goal: stop the bleeding, clean and bandage the wound, prevent infection, and provide comfort.

- If possible, wash your hands before and after helping the person who is hurt.
- Always wear disposable gloves when handling bleeding wounds.
- Use a clean bandage to apply firm pressure to the wound until the bleeding stops.
- When the bleeding stops, gently wash the wound with soap and water. Apply antiseptic to the bandage, and bandage firmly.

Life skills

- Communicating and relating with others
- Problem solving and decision making
- Making good use of your resources
- Staying healthy and in good physical condition, and refining coordination
- Thinking about your future world of work

Goals

- Learn basic first aid
- Know what to do if someone chokes on food
- Make a first-aid kit

Supplies needed

- Pencils/pens and paper
- Basic first-aid kit
- Supplies to put together a basic first-aid kit
- Container for first-aid kit





Always have a first-aid kit on hand when doing any type of outdoor cooking or activity.

- If there is glass or another sharp object in the wound or the wound is deep, get help from an adult.

Nosebleeds

Your goal: stop the bleeding and keep the person calm.

- Have the person sit erect with head forward.
- Gently pinch the outside of the nose just below the eyes until the bleeding stops.

Splinters

Your goal: remove the splinter, if possible, and keep the person calm.

- Clean skin with soap and water or alcohol.
- Remove the splinter with a sterile needle or tweezers.
- Apply diluted hydrogen peroxide (half water, half peroxide).
- If you can't remove the splinter, get help from an adult.

Stings and bites

Your goal: keep the person calm, and if there is a severe allergic reaction (puffy at site of sting, tingling up and down from site of sting, puffy eyes, sweating, difficulty breathing), call emergency services immediately and your adult helper.

- Wash the bite/sting with soap and cool water.
- Remove the stinger by flicking with a fingernail. Do not squeeze.
- Apply a paste of unseasoned meat tenderizer or baking soda and water, or medication intended for stings and bites.
- Apply ice wrapped in a cloth to help reduce swelling.

Burns

Your goal: keep the person calm and prevent infection. Burns can be 1st degree, 2nd degree, or 3rd degree and caused by heat, chemicals, electricity, or radiation. Prevention is most important.

- 1st degree burns involve the top layer of skin. The skin is red, dry, and usually painful. Apply cool water (not cold) to the area until the pain stops. If there is no danger of the wound getting dirty, do not bandage. If there is, bandage loosely. Do not use medication, petroleum jelly, or any type of fat.
- 2nd degree burns involve two layers of skins. The skin is red and has blisters. The burn area may swell. These types of burns need medical attention. Cool the burn area with cool water, preferably on wet towels or sheets. Apply a clean bandage over the burn area. Call 911 or emergency services if the burn covers more than one part of the body; if the person has trouble breathing; if the burn area involves the head, neck, hands, feet, or genitals; or if the burn is caused by chemicals, explosions, or electricity.
- For severe 3rd degree burns, remain calm and get emergency

3B. READY TO HELP

help immediately. Call 911 or emergency services; in the meantime, if possible, cool with damp towels or sheets and treat for shock.

Something in the eye

Your goal: prevent further injury and the threat of blindness.

- If the person's tears don't wash the object out, gently rinse the eye with water.
- If this doesn't remove the object, cover the eye loosely with gauze.
- Get the person to the doctor or hospital immediately.

Choking

Your goal: remove the object/food lodged in the airway passage.

A small object or food lodged in the airway passage can cause choking and stop the flow of air. The following method is used with a person over the age of 1 year.

Do not try to remove the object with your fingers. This might push it further into the throat. If the person is coughing hard, is able to speak, or is breathing, let him or her try to cough the object out. If he/she can't cough it out, act fast. Don't give the person anything to drink. Call 911 or emergency services. Start this lifesaving Heimlich maneuver:

- Stand behind the person and wrap your arms around the person's waist.
- Make a fist with one hand and place the thumb side of the fist against the middle of the person's belly, above the navel and below the rib cage.
- Grab your fist with the other hand.
- Give quick inward and upward thrusts.
- Continue till the object is coughed up or the emergency service persons arrive.

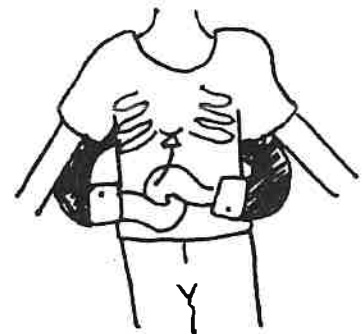

The Heimlich maneuver

There's more

Let's get into it

Make your own first-aid kit. Find a small, sturdy, cardboard or plastic box that is just big enough to hold the following: adhesive tape and roller gauze bandages, assorted sizes of self-adhesive bandages (such as Band-Aids®), gauze pads, large triangle bandages, disposable latex/vinyl gloves, baking soda, hydrogen peroxide, matches, sterile needles, petroleum jelly, safety pins, scissors, soap, tweezers, plastic bags, flashlight, bottle of distilled water, paper drinking cups, tongue depressors, and a list of emergency phone numbers.



An ounce of prevention: checklist

- Emergency numbers easy to locate
- List to check area for safety (example—is there a bee's nest in the area?)
- First-aid kit easy to locate at activity
- Correct supplies and equipment for cooking activity
- If using a fire, is the water bucket by the fire?
- Always replace used supplies
- Add more ideas

Deeper we go

Have a general first-aid kit at each meeting and activity. Design and put together a first-aid kit for your club and yourself. List all the items in the kit and how to use each item. At your meeting, learn and practice first-aid for cuts, burns, and nosebleeds.

Develop a checklist to help keep accidents from occurring.

Another important first-aid procedure to know is CPR—cardiopulmonary resuscitation. This is rescue breathing and should be done only when you have been trained properly.

Work with your adult helper to make your backyard a safe place for outdoor cooking; make a list of the things you do to make the area safe. Make an educational display about first aid in outdoor cooking.

Find out what careers and volunteer positions require first-aid training.

Help organize a first-aid course for your group or friends.

So what?

Talk with your adult helper about how you can help prevent accidents, and if accidents happen, how you can be ready to help. What kinds of first-aid items are needed at every project meeting, especially when cooking? When do you give first aid? Why is it important to know how to do first aid? Who is first aid for? How can you remember what to do if an accident happens?

Now what?

Find out who offers first aid and CPR courses in your community, how much they cost, and when the courses are conducted. Let your family and friends know what's available too. Practice first aid with your family and friends. Make a safety checklist to think through

3B. READY TO HELP

possible outdoor cooking accidents.

Research your community for emergency services. Make a list of emergency numbers for each member and adult helper to keep with them. Know whom to contact for help.

Find out whom the Heimlich maneuver was named after; and how to give first aid to a child under 1 year old who is choking.

Give a presentation on first aid to your group, and/or contact a qualified person to talk with your group about first aid.

Resources

Babysitting Basics: First Rate Sitters, by Williams and Corey, Ohio State University.

Out & About: A Resource for Troop Camping, Western Rivers Girl Scout Council.

Emergency Care and First Aid Manual, A Guide to Handling Medical Emergencies and Routine Health Care, Dr. Lee Salk's Super Sitters.

American Red Cross First Aid/CPR/AED Program Participant Booklet, 2001.

3C. Fuel for Fire

Steve Fitzgerald, area Extension forester, Deschutes County; and
Elaine Husted, Extension 4-H agent, Grant County, Oregon State University

Life skills

- Communicating with others
- Problem solving and decision making
- Finding, understanding, and using information
- Making good use of your resources
- Working with groups
- Thinking about your future world of work

Goals

- Know different wood fuels for cooking fires and when to use them
- Know how to use a knife and hand ax safely

Supplies needed

- Examples/pictures of fuels—different types of wood from your area (pine, fir, maple, oak, etc.), charcoal briquettes, propane, dried cow/buffalo dung, etc.
- Pocket knife and a hand axe (hatchet)
- Pieces of soft wood or soap
- Wood for splitting—dividing a log into smaller pieces
- Wet and dry wood samples

Preface

Safety is the most important thing to keep in mind when around fires: use tools correctly, have your first-aid kit with you, have an ample water source, and use the appropriate fuel. While it would be nice to have a selection of wood available, you will, of necessity, use the hardwoods and/or softwoods that are in your area. Remember, you are learning to make a small cooking fire, not a bonfire, so you won't need a lot of wood. Never build a fire or use a grill or an outdoor propane stove in an enclosed building, as carbon monoxide poisoning might occur and/or the building might catch on fire.

Here's what's important

There are many fuels used to make fires. The type of fuel you need depends on the kind of fire you are building and the available fuel source. Fuel sources can be solid (wood, charcoal briquettes), liquid (kerosene—a thin, nonexplosive, hot-burning oil used in stoves), bottled gas (propane), or electricity. In future lessons you'll be learning about briquettes—the most common solid fuel for backyard cooking—and propane. A reminder, though: never start a propane stove with the lid in the down position, as propane gas can accumulate under the lid and explode, particularly if the stove does not ignite on the first try. Read and follow the instructions for propane equipment. Your adult helper must assist you.

When using a solid fuel, such as wood, the goal is to burn the fuel until hot coals are formed. Allow at least 20 to 30 minutes for coals to form before cooking your food. Avoid cooking over flames because the heat is uneven, often burning the food on the outside while leaving the inside uncooked and unsafe.

Wood is one of the solid fuels used in outdoor cooking. Wood comes from two types of trees: softwoods and hardwoods. Conifer trees—such as pines, fir, tamarack, and cedar—are softwoods. Conifers retain their needles all year long, except tamarack, which loses its needles every fall. Softwood trees tend to have more pitch (sticky sap) in them and burn more quickly. Deciduous trees, which lose their leaves in the fall, are hardwoods. These include maple, oak, birch, and many others.

Here is the confusing part: some conifer “softwoods” actually have very hard wood and make good fuel for fires. Tamarack and Douglas-fir are good examples. Some deciduous “hardwoods” have very soft wood which burns quickly and does not make good coals for

3C. FUEL FOR FIRE

cooking, although it makes good kindling to start a fire. Poplar and aspen are good examples of this.

Softwoods such as pine, spruce, and cedar burn quickly, cook rapidly, and leave few glowing coals. Some softwoods, such as pine, have a lot of pitch in them, making a very smoky fire that “pops” as the pitch explodes. Hardwoods, such as oak and maple, burn slowly, sometimes taking an hour to burn down to coals. They provide excellent coals for broiling, baking, and toasting. No matter which wood you use, select some large pieces that eventually will burn down to produce long-lasting coals.

Wood ignites more easily and burns hotter if it is dry. Look for cracking at the ends of split wood. Cracks indicate the ends are dry. Knock two pieces of wood with cracked ends together. They’ll make a sharp cracking noise if they’re dry. A dull thud indicates the pieces are wet. Avoid wood with a pithy center, because it gives off little heat. Use split wood rather than round, smooth wood.

There’s more

The tools you use when building a campfire usually are a knife and a short-handled axe (sometimes called a hatchet). A good camp axe should be light, well-balanced (the head is not too large nor heavy for the length of the handle), sharp, and carried in a sheath when not in use. For safety’s sake, keep at least 5 feet away from others when using the axe, and always use a log or stump for a chopping block—never a rock. Use the kneeling position, with your hands low to the ground, when using an axe; cut small wood diagonally, at an angle or wedge, or split off small pieces of kindling. Always cut away from you; keep the wood between you and the axe. Adults sometimes use a large axe for chopping and splitting large logs.

Your camping knife should be easy to carry and have a good cutting blade. Folding pocketknives are safer to use than other knives. Keep the knife closed when not in use. Be at least 5 feet away from anyone else when you are using your knife. Always cut away from you and never cut with your hand or thumb in front of the blade. Keep your knife sharp and clean. When you let someone use your knife, make sure it is closed before passing it to him or her.

Let’s get into it

Using the wood samples, compare the wood grains. How are they alike? Different? Can you tell which are conifers and which are deciduous? Is there a difference in the way they smell or feel?

Try this experiment: Find two pieces of wood of the same size, weight, and species. Soak one piece in water for 3 to 4 hours. Compare the weights of the two pieces. The difference in weight is

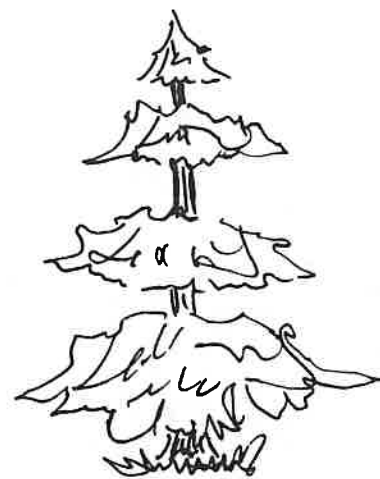

Softwoods (conifers) such as pine, spruce, and cedar burn quickly, cook rapidly, and leave few glowing coals.



Hardwoods (deciduous trees), such as oak and maple, burn slowly, sometimes taking an hour to burn down to coals.

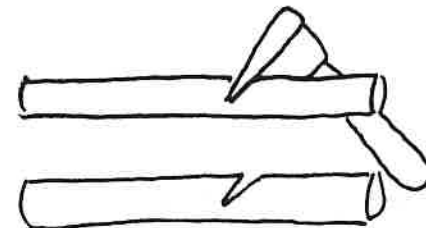

Cut small wood diagonally, at an angle or wedge.



the weight of the water in the wood. Wood that has a lot of water in it is difficult to ignite and does not burn hot or create good cooking coals.

Using soap or softwood, practice your knife cutting skills. Remember to cut away from you and not toward another person. Make sure your adult helper is present when you do this. Have your adult helper work with you so you can use a short-handled axe properly for cutting and splitting small wood. Always split wood from the small end to the big end.

Deeper we go

Tour different campsites in your area and see what kinds of fuels are available for cooking fires. Make an educational display on available wood in your area and/or give a presentation on various fuels available for cooking fires.

Conduct and/or participate in an identification contest on wood and other types of fuel.

Invite a professional forester to talk to your group about jobs related to forestry.

Compare prices and qualities of knives and axes available in your area. Do an educational display or presentation on the various types of knives/axes (both short- and long-handled).

Research the fuels pioneers used when crossing the prairie states.

Report on what other countries and cultures use for cooking fuels today.

So what?

Talk with your helper about the pros and cons of cooking with wood. How would it compare to other types of fuel, such as electricity, propane, or charcoal briquettes? Which would be the cheapest to use? Which is the most efficient? What is the best fuel to use in your area? What factors determine what fuel source you use? What is a deciduous tree and what is a conifer tree? Why is it important to know the difference between softwood and hardwood? When is it appropriate to use your knife or axe? Why is safety important when using your knife/axe?

Now what?

Gather different types of wood fuel sources. Make a tree cookie (a crosscut slice about 1 inch thick) of each wood. Observe the rings and the density of the fibers. Was there a drought during growth? Was there a fire? How can you tell these things by observing the

Footnote fact

Dried cow dung and buffalo dung were used for cooking fires when people were crossing the prairies in covered wagons. There were few trees for wood fuel on the prairies.

3C. FUEL FOR FIRE

rings? Label them to the best of your knowledge.

Resource

Fieldbook, Boy Scouts of
America, 1984

3D. Safe and Orderly Cooking

Shana Withee, Extension agent, Harney County, Oregon State University

Life skills

- Problem solving and decision making
- Making good use of your resources

Goals

- Identify hazards in outdoor cooking areas
- Learn how to make a personal “mess kit”
- Gather additional equipment for your Outdoor Cooking Kit
- BONUS—Make a heavy-duty apron and towel totes

Supplies needed

- Tightly covered plastic container for bleach solution
- Chlorine bleach
- Plastic dishes and old silverware for “mess kit”
- Supplies for making BONUS projects: heavy-duty apron and towel totes

Here’s what’s important

Safety first: Have your adult helper handle the chlorine bleach. It is hazardous to your eyes, can irritate your skin, and will cause damage to clothing. Read the label carefully!

You’ve already learned how important it is to keep food safe by washing your hands before and during food preparation. Especially after working with raw meat or poultry, be sure to wash your hands before touching any other foods. Sanitize the cutting surfaces and utensils you’ve used with a bleach solution (1 Tbsp bleach in 1 gallon of water) before using them for any other food preparation.

Think of some other things that will make your outdoor cooking as safe as possible. Just for fun, complete the Hazard Identification picture (next page). What are the unsafe practices shown? How would you correct them? What can you do to make your outdoor cooking experience safer?

An apron protects you from heat or sparks and keeps grease off your clothes. Look for an apron—or make our BONUS one—that is of sturdy fabric, like denim, and long enough to protect you. There’s no room here for frilly aprons, long hanging ties, or loose clothing; keep long hair secured back.

You also will need to be responsible for your own dishes—often called a “mess kit”—when you go camping. You will wash, rinse, and sanitize your own dishes each time you use them so you’ll know they’re clean. If all of your dishes are metal or plastic, you won’t have to worry about them breaking. Remember, these don’t have to be fancy—just very sturdy! Write your name on the bottom of each piece with a permanent marker that writes on all surfaces and won’t wash off.

Let’s get into it

What do you need in a mess kit? A flat dish with 1-inch sides will make it usable for “soupy” dishes as well as firmer, flatter foods. A large cup can be used for soups as well as hot chocolate and orange juice. You’ll need a fork and spoon, for sure, and a knife if you don’t have a pocketknife. Because your pocketknife folds up, it’s harder to get it clean in all the little crevices, so you might not want to use it for food. Put your “mess kit” together in a mesh bag—one that has holes in it—so you can hang it from a tree limb to dry your dishes!

3D. SAFE AND ORDERLY COOKING

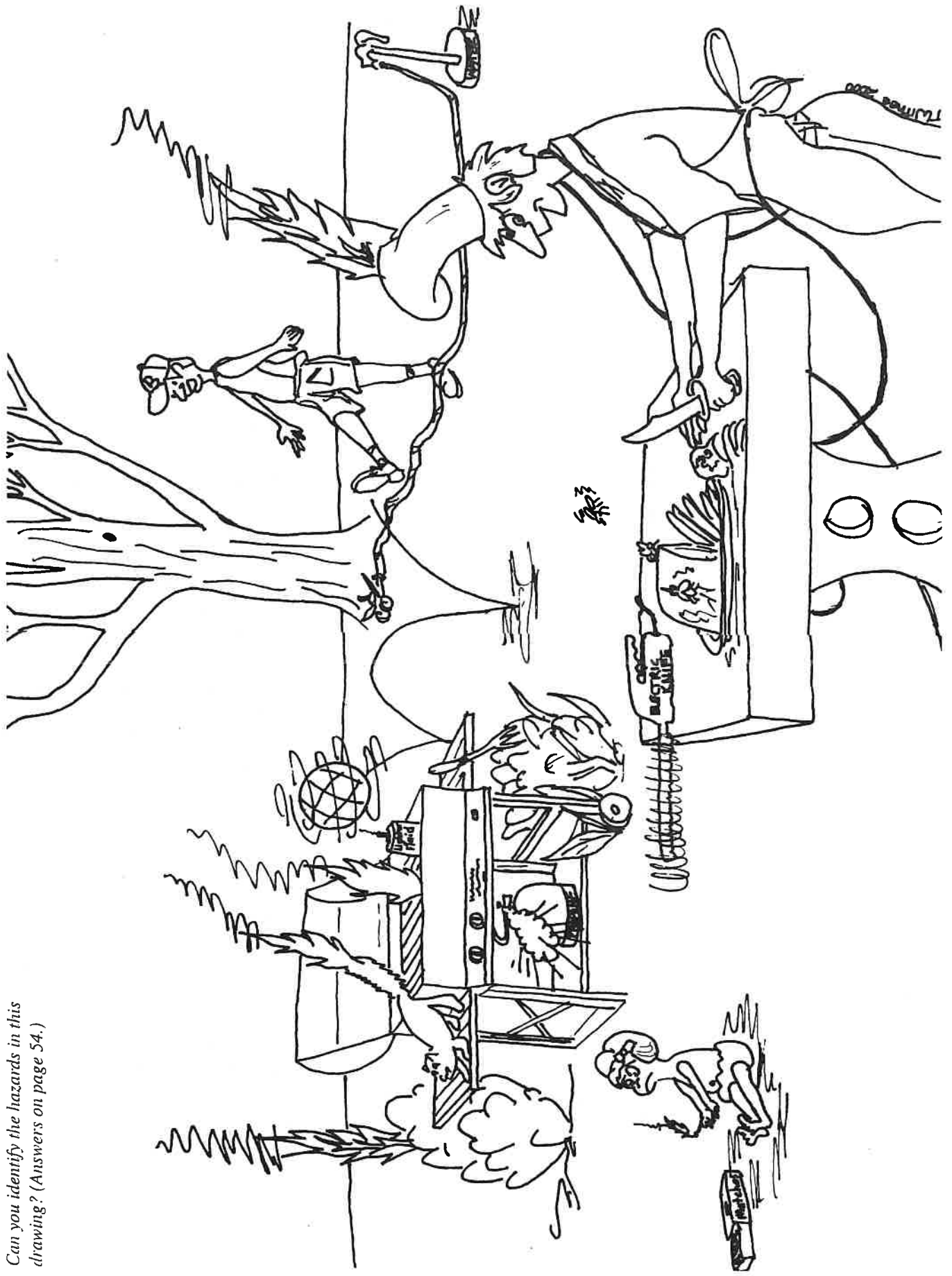

Can you identify the hazards in this drawing? (Answers on page 54.)

There's more BONUS sewing project

Materials for apron construction:

- 1 yd heavy woven cotton canvas, sailcloth, or denim (makes two)
- Chalk or marking pen to draw cutting lines
- 2½ yd cord to match (for each apron)
- Scissors
- Tape measure
- Iron-on, fusible web (to fuse—glue—your hems and casings) OR sewing machine and matching thread

Figure 1

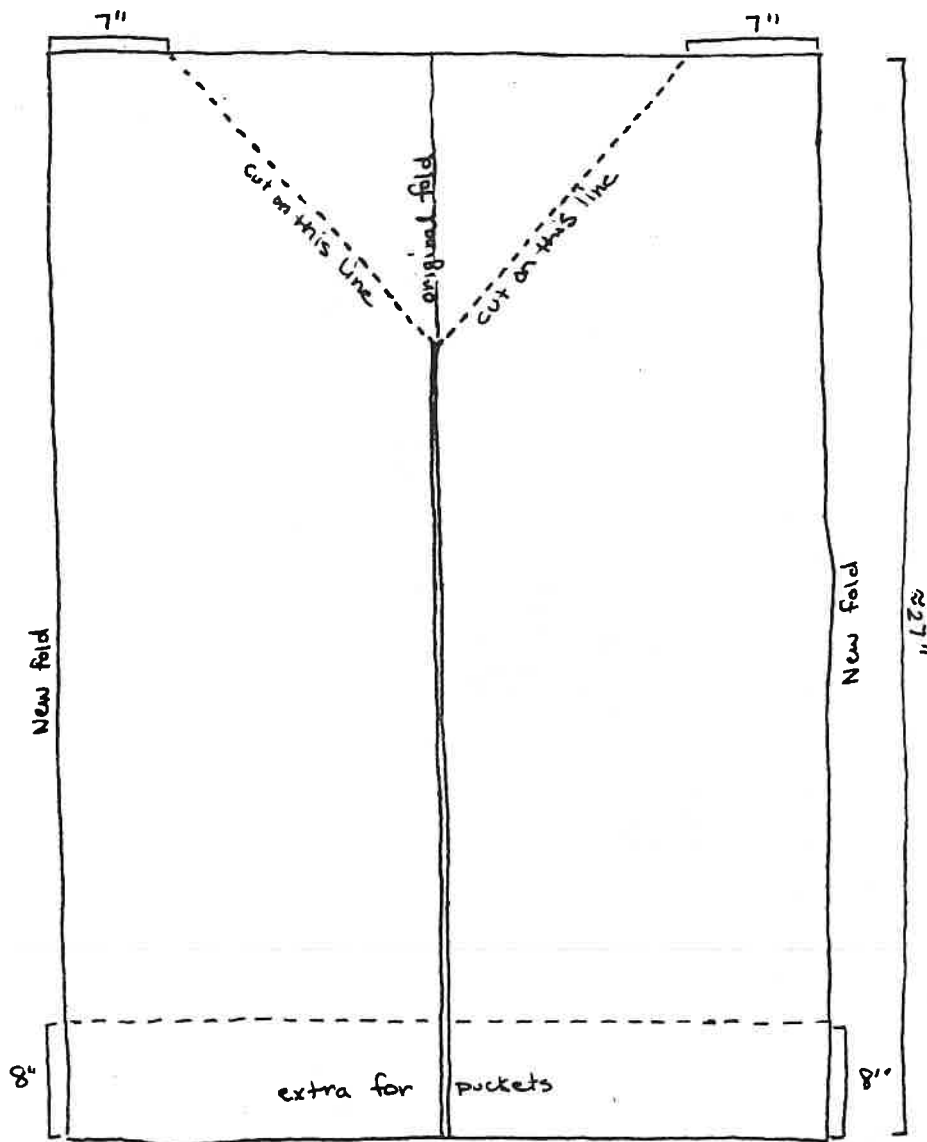

Apron instructions

- Remember Safety First. Handle your scissors and sewing machine with care!
- Refold your fabric so there are two folds (Figure 1). This makes two aprons!
- Use the diagram to measure the aprons and draw lines. These will be your cutting lines.
- Cut out pockets. Decorate pockets with buttons or fabric crayons. Be careful that you don't add a hazard to your apron.
- Turn under a 1-inch hem on the top of the pocket. Stitch or fuse. Press under other three edges ½ inch.
- Center the pocket(s) on the top or middle of the apron. Stitch. Do a close zigzag (bar tack) at the corners to keep the pockets securely attached.
- Turn under a ½-inch hem on the apron top, long sides, and bottom. Sew or fuse. Do not hem the diagonal edges.
- On the diagonal edges, press under ½ inch. Press under another 1½ inches. Stitch

close to the inside edge (Figure 2). This forms a casing. Insert matching cord through the diagonal casings with a loop for your neck at the top. Knot the ends.

3D. SAFE AND ORDERLY COOKING

You are now ready to barbecue safely with your new apron! Make one for a friend, too!

Let's go deeper

Another handy camping accessory is a "towel tote" that can be used with your meals as a placemat, a napkin, and a silverware holder. Make a second for your personal care items!

Materials for towel totes:

- Two hand towels with hemmed, not fringed, ends—darker colors show dirt less!
- One pair of short shoelaces for "towel totes"

Sewing instructions

Turn up the hemmed edge 6 inches, forming a pocket. Now stitch up the sides of the pocket and then add small "pocket" stitching lines in the big pocket for your knife, fork, spoon, can opener...and your cloth napkin (if you're bringing one along) (Figure 3).

On the second towel, stitch pockets for your toothbrush, toothpaste, small shampoo, soap, comb, and other items you need to get ready for bed. Fold the shoelace in half and sew to the outside middle of your pockets on each towel. Now they're ready to fill, flip the top over, roll, tie, and put in with your camping gear! When you get home from camping, empty your "pockets," wash with your other camping clothes, refill, and place in your outdoor cooking gear! You're ready to go on another outdoor adventure!

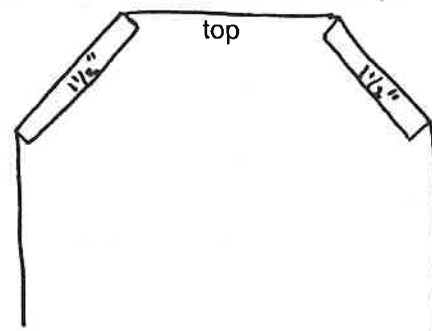

Figure 2

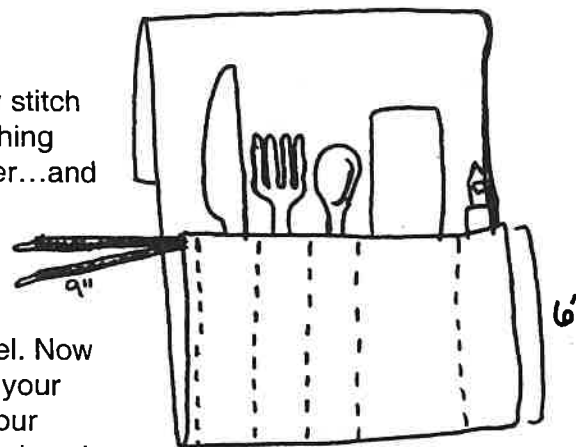

Figure 3

So what?

Talk with your helper about the importance of hand washing and keeping raw meat juices away from ready-to-eat food. Remember cleanliness of hands, utensils, and surfaces is most important in the preparation for cooking.

Talk about the hazards shown in the Hazard Identification drawing (listed on the next page). Can you think of others that might be a problem? Correct any hazards at your favorite barbecue spot.

How did your apron turn out? Were you able to stitch all of the hems evenly? Is the cord the right length so it will not hang in the fire?

Evaluate your "Mess Kit." What else might be added? Would something else be easier to clean? Is the container in which you store your mess kit unbreakable? Does it keep the supplies together and clean? What else could you use your "towel tote" for?

Answers to “hazards” drawing (page 51)

- Pet (cat) on food grill
- Lighter fluid on grill
- Grill too close to the shrubs
- Propane bottle connection loose
- Utensils (fork) carelessly lying around
- Baby playing with matches
- Electric knife operating unattended
- Playing ball in cooking fire area
- Water hose lying around, tripping child
- Meat uncovered and attracting flies
- Not cutting food on a sanitary cutting board
- Electrical cord wrapped around chef
- Chef’s hat on fire

Now what?

Teach others how to wash their hands correctly—round the fingers and up to the wrists. Remember to hum/sing the birthday song, so you’ll wash your hands long enough to get off the germs.

Wear your apron every time you cook outdoors. Make another apron, or other outdoor cooking equipment, for a friend or someone else in your family that cooks with you. Teach your family what you’ve learned about safe outdoor cooking practices.

3E. We Can Cook!

Miriam Lowrie, retired Extension 4-H agent, Oregon State University

Here's what's important

Backyard cooking is a good place to start your outdoor cooking adventures. There are many different cooking units (containers in which a heat source is held to cook food) and fuel sources to choose from.

Cooking units

Charcoal, gas, and electric are three types of barbecue units. Some look like a kettle and others like a box, from tabletop size to large floor units; some even have wheels! For an individual unit, you could even use a large, clay flowerpot with charcoal briquettes in the bottom and a cake cooler on the top. Put a few rocks between the pot and the base to allow air to flow in, to keep the charcoal burning.

Units heated by electricity or gas don't require building a fire, take only a brief time to preheat, and don't have ashes to clean up. Indoor, gas, and electric units are permanently installed by the kitchen range; they must have an exhaust fan to be safe to use. Gas and some electric units use a special briquette-shaped material, such as lava rock, above the heating element to radiate heat evenly to the food. When meat juices drip on the hot lava rock "briquettes," smoke rises and penetrates the food. It's the smoke, not the briquettes, that gives food a "barbecue" flavor. Most outdoor propane units use portable tanks or canisters of gas; electric units must plug into the nearest outlet.

Fuel sources

When lighting a barbecue unit, remember "safety first." For gas units, make sure the valve is in the "off" position when attaching the gas. Turn it on only a second or two before lighting the unit. Remove the cover, turn on the fuel, and use a match to light the gas. If gas fills the lid first it will explode if a match is lighted nearby. Always strike a match away from you.

Charcoal units require briquettes, which are lighted and preheated for about 30 minutes before cooking. When using charcoal briquettes:

- Make sure the charcoal unit's vents are open to allow oxygen for the fire to burn.
- Place 20 to 30 briquettes in a pyramid shape in the middle of the unit. The number of briquettes depends on how big your unit is, how much food you have to cook, and how long it will take to cook your food. Use about as many coals as the space your food takes when spread out to be cooked—although a bit more

Life skills

- Problem solving and decision making skills
- Finding, understanding, and using information
- Making good use of your resources
- Staying healthy

Goals

- Know about different barbecue units and how to use them.
- Know how to light and cook safely on a gas or charcoal barbecue unit.
- Know safety and quality standards of well-cooked meats.

Supplies needed

- Several types of barbecue units (if available), charcoal briquettes, charcoal lighting fluid, wooden matches, bottled (tank/canister) propane gas
- Ingredients for one or more recipes to cook on the grill.
- First-aid kit

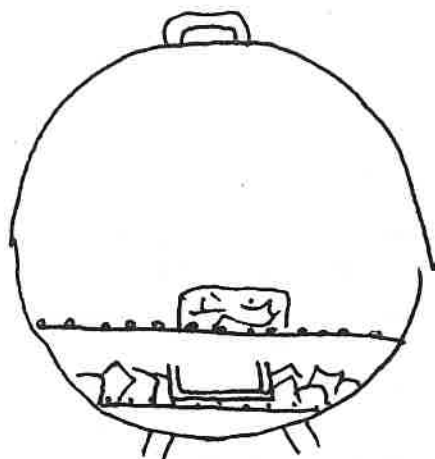

Indirect heat

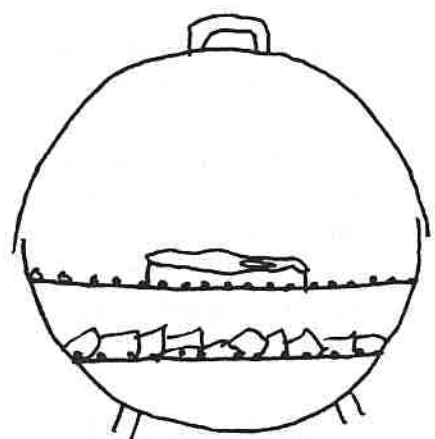

Direct heat

will make a hotter, faster fire.

- Place three or four small “wads” of paper into the pile of briquettes, and/or squirt a small amount of charcoal lighting fluid on all the briquettes just once. Never add more fluid to a fire that has already been started—the flame could jump back into the container and explode! Let the fluid soak in.
- Light the briquettes with a wooden match—long-handled matches are best. Heat the briquettes for approximately 30 minutes. They are ready when gray ash covers them and they glow. If you need more briquettes, add them around the edges of your fire, as new coals cool down the fire while they are heating.
- Never use a charcoal briquette unit indoors. Carbon monoxide, an odorless gas given off in burning briquettes, is poisonous, and its production uses up oxygen in confined areas.
- When the coals are ready, chose between direct and indirect heating. Smaller, thinner cuts of meat are cooked right above the coals with direct heat. For indirect heat—used for larger cuts, roasts, and whole birds—place the food over a center pan (into which drippings fall) with coals banked on each side of it. Use a cover with indirect heat to cook food faster. Cook meat until juices run clear.
- After cooking, close all air vents and cover the unit to put out the coals. Store coals in a smaller container, using tongs to remove hot coals to a large, clean, metal can, and cover it tightly with foil. Using your heat-resistant gloves, place the metal can on cement, sand, or dirt. Do not move a hot unit. After putting out the fire, allow several hours for cooling before storing the unit.

The grill

Food is cooked on a flat grill (stainless steel or other food-grade metal) over the barbecue unit. Set the grill about 6 inches above the heat source—or a bit higher for food that must be cooked more slowly. Some grills are adjustable. You also can use a grill placed on cement blocks on a patio, or on bricks in a wheelbarrow or a wagon (filled with sand to protect the surface from the heat). Place the flat grill on brick or log supports over the coals—higher supports will take the food longer to cook because the fire is farther away.

Some other equipment to have on hand for barbecue grilling:

- 1) Well-insulated gloves (leather welder’s gloves are best when your hands are bigger) or long oven mitts for hot jobs near the fire—some even have fireproof linings!
- 2) Apron—a heavy-duty one—to protect you from heat and sparks and keep grease off your clothes
- 3) Long-handled tongs and/or spatula for turning and lifting foods—forks puncture the food and let the moisture out!
- 4) Spray water-bottle to douse flames and flare-ups
- 5) Long-handled basting brush for sauces

Let's get into it

Light the charcoal unit about 30 minutes before you cook. An electric and/or gas unit can be started just prior to cooking. To prepare meat on the grill: Remember to wash your hands, utensils, and surfaces before you start. Keep meat in the refrigerator until you're ready to prepare it for cooking.

Use different plates and utensils for raw and cooked meats, and don't let the raw meat juices touch ready-to-eat foods such as salads or breads. Try hot dogs first on the charcoal unit, the electric unit, and the propane unit. How long did each of them need to cook? Were they different distances from the heat? Did they taste different? Which did you like best? Try some other recipes!

Barbecuing chunks of meat over an open fire was probably one of the first types of outdoor cooking. The tantalizing flavors of herbs, roots, and berries crushed and drizzled over cooking meat probably were the first barbecue sauce.

Here are some good recipes to try.

All-purpose barbecue sauce

(to prepare indoors before you start!)

2 tsp sugar, granular or brown

½ tsp pepper

¼ cup vinegar or lemon juice

⅓ cup catsup

⅓ cup tomato juice

Dash of salt

Mix together ingredients until well blended. Brush over meat as it is barbecued.

Steak

Slash fat edges of meat to prevent curling. Rub lightly with butter to prevent sticking on grill. Place on grill 4 to 5 inches above hot coals. For medium rare, broil about 15 minutes on one side and about 10 to 12 minutes on the other side. Baste occasionally with barbecue sauce as cooking progresses.

Spare ribs

Cut into four or five rib sections between bones. Rub rib rack lightly with butter to prevent sticking to the grill. Cook slowly about 6 inches above hot coals for 45 to 60 minutes. Turn often and brush with barbecue sauce. Be sure the meat is well done.

There's more

Here are some other fun foods to try on your barbecue unit.





Blueberry muffin bread

1 package blueberry muffin mix OR 1 recipe blueberry muffins
Two 9-inch foil pie pans
Butter or margarine
Spring-type clothespins

Lightly grease the foil pans. Prepare muffin mix according to directions; pour into one of the pans. Cover with the second pan, inverted. Secure rims together with clothespins. Place on grill over hot coals. Cook for 15 minutes on each side, rotating pan occasionally for even baking. Remove top pan; cut bread into six wedges. Serve with butter/margarine. Makes 6 servings.

Zebra pizza

Your favorite biscuit dough
½ tsp salt
1 can pizza sauce
1 package pepperoni

Two 4-oz packages shredded mozzarella cheese

Prepare biscuit dough as directed on package, except add ½ tsp salt with baking mix. Divide dough into four parts. Pat each part into a circle. Grill circles over low coals for 6 to 8 minutes or until lightly browned—except for stripes! Turn circles over and spread with pizza sauce. Add other favorite pizza toppings. Cook about 6 to 8 minutes longer until cheese bubbles and edges are browned.

Deeper we go

A meat and fish quality checklist

- Ground meats must reach 160°F internal temperature and have no pink meat
- No red at poultry joints, and meat should pull easily off the bones
- Meat juices should run clear
- Fish should flake
- Meat cooked to medium doneness will have a little give when touched by the fingertip
- Using a meat thermometer, check the internal temperature of hamburgers and other meats as they cook.

Footnote facts

Charcoal briquettes were invented by Henry Ford as a way to use scrap lumber from wooden car bodies after World War I.

“Barbecue” is from the Mayan word “barbacoa,” which is a lattice of thin, green sticks suspended over an open fire.

So what

Talk with your helper about the advantages and disadvantages of gas, electric, and charcoal grills. Which would be best on a camping trip? Which would be easiest to clean? Which would take the least amount of time to be ready for cooking? How did your recipes turn out? How long did you wait to have enough heat to cook your food adequately? Did you use direct heat or indirect heat? With which method do you have more chances of burning your food? How did

3E. WE CAN COOK!

you know when your food was done? Which method of testing your food did you use? What cooking method that you're already familiar with is similar to grilling? How is the flavor different?

Now what

Practice several types of grilling—over direct heat or indirect heat, covered or uncovered. Try different types of meat and fish. Marinades and barbecue sauces add different flavors to grilled foods. Try some purchased sauces, or find recipes with your favorite flavors. To prevent scorching, don't add barbecue sauces until the last 10 to 15 minutes. Teach your family what you've learned about safety when you barbecue food.

Compare the time needed to preheat charcoal vs. gas grills plus costs to buy and keep each of them operating. Make a chart showing the difference.



Chapter 4—Safety First

4A. What Shall We Eat Today?

Miriam Lowrie, retired Extension 4-H agent;

Janice Smiley, Extension EFNEP agent, Multnomah County;

Billie Stevens, Extension 4-H home economist, Hood River County; and

Beth Upshaw, Extension 4-H program assistant, Union County, Oregon State University

Life skills

- Understanding yourself
- Communicating and relating with others
- Problem solving and decision making
- Finding, understanding, and using information
- Staying healthy and in good physical condition, and refining coordination

Goal

- Learn how to put foods into a daily menu

Supplies needed

- Food Pyramid
- Magazine pictures of favorite foods
- Pencil and paper

Here's what's important

By now, you know all the groups in the Food Pyramid and the nutrients you get from each of the groups. Can you build a Food Pyramid on your own? What foods go in each “room” of the pyramid? How many servings of each food group do you need each day? What nutrients will you find in the foods in each group to help your body grow, be healthy, and/or give you energy? In what “rooms” will you find foods with proteins, fats, carbohydrates, vitamins, minerals, fiber, and water?

Each day you should get the Recommended Dietary Allowances (RDA) of each nutrient your body needs. It's hard work to keep track of grams and micrograms for every food you eat and all the nutrients you need. Instead, review the number of servings and the amount of each serving needed. “Fiber” does not have a group of its own and is found in whole grains, fruits, and vegetables. Fiber is very important to keep your food moving through you. Eat fiber foods each day!

Each food you eat gives you calories—a unit of measuring energy released from food when it is metabolized (used) by the body. Look at nutrition labels on packaged foods for how many calories are in each serving. Some calories give you more energy than others—for example, you'll get 9 calories for each gram of fat but only 4 calories for each gram of carbohydrate or protein. Whether you're having fun in your back yard or going on a hike, you need to eat enough calories to keep you going.

The more active you're going to be, or the more extreme the weather conditions you'll be in, the more calories you'll need. For example, the National Outdoor Leadership School recommends 2,500 to 3,000 calories for teenagers doing summer/leisure day hikes, and up to 4,000 to 5,000 calories for teenagers on cold days and extremely cold nights carrying full packs in mountain environments. That's almost twice as much food for backpackers in extreme conditions doing high-exertion-level hiking! What kinds of food are going to give all that extra energy?

Let's get into it

Using the Food Pyramid as a guide, put together foods to make meals. These meals will give you the energy (calories) and nutrients you need to keep going. This is called planning a menu. When you plan a menu, use foods that your group will eat, "in-season" foods, and "best buys." Think about the aesthetics of the meal, which are: eye (or color) appeal; flavor and texture contrasts; plus a variety of sizes, shapes, cooking methods, and temperatures.

Have you already cut out pictures of your favorite foods for another lesson? Let's use them again to put together some favorite meals for a whole day. Do you have a variety of colors, textures, and flavors? Now, without pictures, but using the Food Pyramid, fill in the chart below with foods that will give you energy and help you stay healthy.

Create a menu

Build your menu from the bottom of the Food Pyramid up. Start with the breads, grains, and cereals group—6 to 11 servings a day. WOW! Where are you going to fit all those in? Plan for three meals—a breakfast, a lunch, and a dinner (in some order)—and snacks for an overnight camp adventure. Remember, use your imagination and make sure the food is nutritious and stays safe to eat. Here is a chart you can use when planning your meals.

Chart for menu planning

Breakfast		Lunch		Dinner	
Breads and Cereals		Breads or Cereals		Breads, Cereals, rice or noodles	
Fruit or Juice		Fruit or Juice		Fruit or Juice	
Vegetable		Vegetable		Vegetable	
Protein food		Protein food		Protein food	
Calcium food		Calcium food		Calcium food	
Beverage		Beverage		Beverage	
Mid-Morning Snack		Mid-afternoon snack		Bedtime Snack	
Cooking Supplies**		Cooking Supplies**		Cooking Supplies**	
Groceries needed		Groceries needed		Groceries needed	
Cooking Equipment		Cooking equipment		Cooking equipment	

**Basic staples, such as seasoning, oil, salt and pepper



There's more

Snacks are an important part of your diet. They are easy to grab and give you energy. Some have long-lasting energy and others give you a quick burst of energy. Here are some foods that give long-lasting energy for the size of the snack: cheese, gorp, meat sticks, nuts, energy bars, granola, and peanut butter. Snacks that give you a quick burst of energy—they won't last long!—are candy, pop, honey, and sports drinks.

Deeper we go

Plan a menu for your family for a whole weekend. Be sure to include favorite foods of each person at some time. Is everyone getting the right number of servings daily based on the Food Pyramid? How big are their servings? What would you need to change in your menu plan if you were going camping for the weekend?

So what?

Show your helper your menu plan that you filled in with the foods you eat. How many servings did you get in each food group? What are your favorite foods in each group? What foods would you like to try to get more variety in your diet? What are some foods that fit in two or three different groups? These are called "combination foods," like pizza. They're good for you, too!

Resources

<http://www.nal.usda.gov/fnic>

Go to food composition, USDA Nutrient Database for Standard Reference, for a complete guide of all foods and nutrients. Scroll down to "Cyberdiet's Database of Foods" and "Cyberdiet's Fast Food Quest" for another great Web site!

"Cookery" by Claudia Pearson (for the National Outdoor Leadership School, 1997)

Nutritive Value of Foods, PNW 357, 2001.

Now what?

Go to a nutrition Web site or get a "Nutritive Value of Foods" book (from your Extension 4-H office or your library) that lists all your favorite foods and their nutritive content. Make a list of your favorite foods and make a chart of the protein; fat; carbohydrates; fiber; vitamins A, B, C, D, and E; calcium; and iron. While there are many other vitamins and minerals, these are the "biggies." If you eat a variety of foods from all of the food groups, you'll usually get the vitamins and minerals you need in small amounts, too. Using your list of foods you actually eat in a day, make a chart of the nutritive values of those foods. Compare your totals with the RDAs for your age group. How are you doing? Where do you need to improve your diet?

4B. Our Friend, the Sun

Miriam Lowrie, retired Extension 4-H agent; and
Marilyn Moore, Extension 4-H agent, Malheur County, Oregon State University

Here's what's important

The sun is the major heat source in our world. We look forward to sunny days and turn our faces to the sun to feel its warmth. The sun seems to fill us with energy! In some parts of the world the temperature gets very hot; some people say “you can fry an egg on the sidewalk” on those days! People have learned to use (or “harness”) the sun’s energy to make it work for them—for example, to generate electrical power. Solar power is using the sun to make energy to heat our homes and cook our food—and sometimes turn on our lights! You might have a calculator at home that runs on solar energy.

Why is solar cooking important? In some parts of the world, wood is not available to burn for cooking fires. If people in those parts of the world want to have a hot meal, the only heat to cook with is from the sun. They use solar reflective panels and ovens to concentrate the sun’s heat on whatever is contained in the solar unit, to cook a hot meal in the middle of the day and other foods for later in the day.

An organization called Solar Cookers International has been teaching people in countries with little fuel, such as Africa, how to cook with solar reflective panels and solar ovens. Between 1995 and 2000, they taught more than 15,000 people in just one refugee camp how to cook with solar energy. A solar cooker costs each family about \$9.00 (U.S.) (from Solar Cookers International’s Solar Cooker Review Newsletter, December 1999).

Because solar cookers do not burn fuel, they do not put any smoke pollutants or carbon dioxide into the air that cause increasing global warming. People don’t use much of their scarce water in cooking, either. Most important, they are not cutting down trees that provide shade for animals and keep the good soil from eroding (washing) down the river.

Safety considerations

Obviously, you’ll need a sunny day to cook with your solar cooker. Even then, it’s hard to determine how long it will take food in your solar cooker to get above 140°F. You know that protein foods must not be left out for more than 2 to 3 hours in the danger zone (40 to 140°F). Because you cannot figure out the intensity of sun or how fast the temperature will get above 140°F, you should only prepare foods in your solar cooker that don’t contain protein. Do not cook meat, especially, with your solar panel. Fruit and vegetable dishes,

Life skills

- Finding, understanding, and using information
- Making good use of resources

Goals

- Learn how the sun cooks our food
- Make and use a Foldable Solar Cooking Panel

Supplies needed

- 36- by 49-inch piece of cardboard
- Black acrylic paint
- Heavy-duty aluminum foil
- Tuna can
- Ingredients for “Camper Cobbler”
- Marking pen
- 1- to 2-inch paint brush
- Knife for cutting cardboard



beverages, and some small-sized basic breads that do not use milk or eggs will be fun to try.

Let's get into it

Build a reflective folding panel that collects and concentrates the heat onto a small surface on which food or beverage is placed in a dark container. This is one of many ways to do solar cooking. You'll need one 36- by 48-inch piece of cardboard.

Mark the indicated lines on your piece of cardboard (Figure 1). The dashed lines are folds only—do not cut on these lines. With your adult helper's assistance, carefully cut out the solar panel on the solid lines. Cut out the small slots on the front reflector part of the panel. Now you're ready to fold. Remember to fold everything toward the bottom collecting station. Use the handle of a table knife or screwdriver to push down on the folding dotted lines so they will crease easily. Fold those straight creases against a hard, sharp, straight edge, such as a counter top.

Now you must prepare your folding solar panel for cooking. Paint

the whole surface black—front and back—to preserve the cardboard. Cover the inside surface, except for the flat bottom, with heavy-duty aluminum foil, gluing it in place. Carefully fold the front and back panels up and fit the bottom corners of the side panels into the slots of the front panel. Now you're ready to cook!

Figure 1

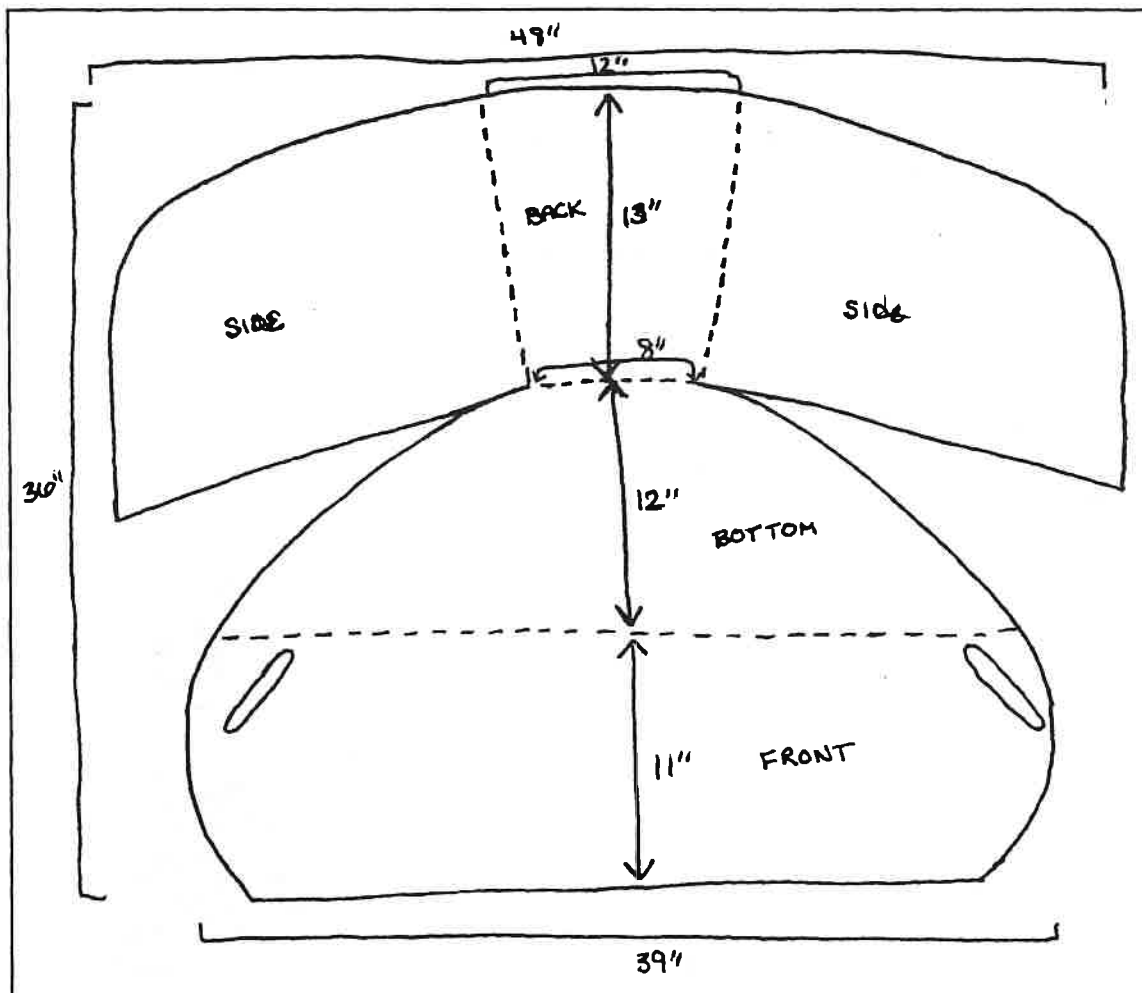

There's more

Here's a Tin Can Stove recipe adapted for your Solar Folding Cooker.

Favorite buddy dessert

Paint a clean tuna can black on the outside.

Mix together:

2 Tbsp packed brown sugar

½ cup flour

½ cup oatmeal

2 Tbsp margarine

½ tsp cinnamon

Fill the greased tuna can ½ full of fruit such as apples, peaches, or berries. Top with mixture above. Pack on top of the fruit. Cover with plastic wrap. Place the can in the center collecting station and cook around noon, in the hottest sun of the day. Turn your oven so the back panel faces south, to collect as much sun as possible and cook faster. After about an hour, check your food to see whether it has heated through to the fruit. Put some whipped cream or ice cream on top when it's done and enjoy your treat and the fact that you've harnessed the sun's energy to cook for you.

Deeper we go

The blind solar cooks

A teacher working with people who are blind in Kakuma, Africa invited the solar cooking project teacher to teach this skill in her independent living class. Some of the students' comments were: "We can attend classes as our food cooks." "Because of our condition, we cannot go around looking for firewood. It is difficult enough trying to walk around. Now we can just put our cooker out in the sun and it cooks." "Meat and rice cooked in the cooker tastes very nice and we cannot burn." "I warm my water for bathing and keep away skin diseases. I boil my drinking water and I am very happy." "I have no children to help me and I cannot work for pay. However, with solar, I can cook potatoes and I don't have to be dependent on other people."

Write a report or give a presentation on all the benefits of solar cooking. Include people with all abilities and needs from all parts of the world.

So what?

Why is solar cooking especially important in some parts of the world? What was the hardest part about making your folding solar cooker? How long did it take for your cobbler to cook? How did it



Resources

<http://solarcooking.org> is the Web site for Solar Cookers International. The newsletter includes articles about their project sites around the world. The Web site has a variety of resources, plans for building solar cookers, past editions of the newsletter, multimedia, and more information of interest.

Countryside & Small Stock Journal, Vol. 82, No. 4 July/August 1998

taste? What other recipes would you like to try?

Now what?

Use a thermometer and see how long it takes your foldable solar cooking panel to get over 140°F. Experiment at different times of the day but with the back panel of the solar panel pointed directly at the sun.

Research other places in the world where solar cooking would be beneficial.

Adapt some other recipes to your solar reflective oven. You probably will need a bit less liquid than is required in ordinary cooking. Try cooking vegetables in a microwave-safe, self-sealing bag, with just a little water and some seasoning to bring out their flavor. Remember, small chunks/slices will cook faster than a large, whole vegetable.

4C. A Safe Cooking Campfire

Jan Pahl, Extension 4-H agent, Clatsop County; and
Dana Martin, Extension 4-H agent, Crook County, Oregon State University

Here's what's important

A fire needs three things: heat, air, and fuel. Air circulation around the wood is critical to a good fire. When sticks are too close, the air cannot get in and the fire smothers. When the sticks are too far apart, too much air gets in and cools the fire below the kindling point (heat temperature at which the fire catches). Piling too much fuel on a fire before it gets started can put out the fire. Add small sticks very carefully, a few at a time, until the fire catches well.

Three types of material are needed to build a cooking fire. They include tinder (to start the fire), kindling (to get it going), and fuel (to keep it burning).

Tinder is small material that catches fire from a match. It should be pieces no thicker than your little finger. Shavings, fine twigs, weeds, bark, and paper make good tinder. Dry grass and leaves also may be used, but they burn out very quickly. Use your fire starters as tinder, too!

Kindling consists of dry sticks and twigs, about the size of a thumb. Split off pieces of kindling from larger pieces of wood. Wood for kindling should be dry enough to snap when broken. Sticks lying on the ground might be too damp.

Fuel is the real fire material. Firm pieces of wood about the size of your wrist or larger make up fuel. Split logs burn more easily than whole logs because the surface is rougher and catches fire more easily.

Let's get into it

A commonly used, basic cooking fire structure is called the "basic triangle" or "cone" fire. It's easy to build for a first campfire. Keep your cooking fire small; it's easier to work around, doesn't waste wood, and is much safer. Build a foundation fire from a handful of tinder and a handful of kindling. A foundation fire makes enough heat to get the fuel burning. Always keep watch over your fire and add fuel as needed to get the bed of coals you'll cook on. Most cooking should not start until the fire has burned down to glowing coals.

To start your fire

- Place a handful of tinder and some kindling in the shape of a cone on the center of the fire circle.

Life skills

- Problem solving and decision making skills
- Finding, understanding, and using information
- Making good use of resources
- Working with groups
- Staying healthy and in good physical condition, and refining coordination

Goals

- Practice safety around outdoor cooking fires
- Know how to build a basic structure for a cooking fire with tinder, kindling, and fuel
- Be able to tell approximate temperatures of fire for cooking by "palm counting"
- Be able to put out a campfire and check to be sure it's out

Supplies needed

- Source of tinder, kindling, and fuel (wood) for cooking fire; waterproof matches
- Firefighting tools—bucket, shovel, water, or sand—if an open fire is planned
- Supply of water for putting out fire
- Camp fire equipment: pocket knife, axe, shovel, and bricks or rocks for fire circle
- First-aid kit
- Supplies for family project



A commonly used, basic cooking fire structure is called the “basic triangle” or “cone” fire.

- Lean three thin pieces of firewood against each other to form a triangle. Leave air spaces within it so it will burn readily.
- Use three wrist-size sticks. Place one stick on the ground over the triangle. Place the end of the second stick on one end of the first stick, forming a “V.” To complete the large triangle, place the end of the third stick on top of the second stick and under the end of the first stick. This design allows air to flow underneath the triangle and a place for your match.
- Light the tinder at the bottom of the pile, because fire always burns upward. If it does not light, add more tinder and try again.
- Once the fire is burning, slowly add more kindling around the cone from smaller sizes to larger.
- If you use a match to light the fire, make sure you throw it into the fire. Never throw a match into the garbage or onto the ground.
- When you’ve made your small fire, you and your adult helper will want to roast some marshmallows and perhaps sing a few songs! It’s time to celebrate your accomplishment!

There’s more

For outdoor cooking, have the right kind of fire ready for the cooking job. High flames are useful to boil water; low flames for cooking in a pot; and the bed of glowing coals furnishes the best heat for frying and broiling. Coals are the best source of heat for cooking most foods, as they provide a steady, hot heat source.

To determine whether the coals are ready to cook over after the fire has died down, use “palm counting.” Place your hand, palm-side down, 6 to 8 inches over the coals—never over a fire, only over coals. Hold your palm in place and count “one and one, two and two, three and three.” If you can leave it there for longer than that, the coals are too cool yet for cooking. A slow (cool) fire takes six to eight counts before the heat becomes uncomfortable to your palm; a medium temperature takes four to five; and hot takes two to three. Remember, don’t put your hand over a fire—only coals!

Safety first!

Never leave a fire unattended. Always have someone watching it. Have at least one camper assigned to tend the fire at all times; rotate this responsibility as cooking proceeds. Always have firefighting tools—bucket, shovel, and water or sand—on hand. Never throw a match into the garbage until the match head is cold enough to touch.

How to put out a campfire

Let the fire die down as much as possible. Scatter coals; knock large pieces of wood apart. Where there is plenty of water, drench the hot coals with water and stir with a stick until all the coals are soaked. The larger sticks and logs will need to be turned and drenched on both sides. Repeat until no live coals remain. Sand or dirt also is good for putting out a fire. Cover the hot coals with a good layer of dirt, starting around the outer edge of the fire. The soil needs to be deep enough so when you put your hand on it, it will not feel hot. Then tramp it down and check again with your hand. When you can press your hand on the spot where the fire was and feel it’s cool, you know it’s out! Your adult helper will be the first to demonstrate this.

Deeper we go

Wooden matches are easier to light than paper “book” matches. Long, wooden fireplace matches are safest. To waterproof your matches, lay several of them side by side, then drip wax from a lighted candle over the heads of these matches. When the wax has cooled, separate each match. Before using them, scrape the wax off the head of the match.

So what?

What are the important safety issues to remember around fires? Why is it important to know what the weather conditions are? What are suitable weather conditions for lighting a cooking fire? What are the three types of material needed to build a cooking fire? How do you know when a fire is ready to cook food over? How did your first cooking fire do? Did it die out or did it burn down to coals in order to enjoy a treat? Which method did you use to put your fire out? What supplies would you need for each different way to put out (douse) a fire?

Now what?

The people in charge of watching our forests to keep fires from getting out of control have a big job. They must watch miles and miles of trees day after day and make sure they don't miss even the smallest sign of a fire. If the wind starts to blow hard, a fire spreads very quickly and destroys a lot of our natural resources. Visit a forest ranger or a fire lookout tower manager to learn more about the important jobs they have to keep our forests beautiful. What did they study to do their job? What do they like about their job? How can you help the forest rangers do their job?

Here's a family project: Roll several newspapers tightly until they are 4 inches in diameter. Tape all around the outsides to hold the paper log together. Using a cutting board and an appropriate sharp knife, cut the paper log it into 1-inch sections. Place the rolls of paper into melted wax in the top of a double boiler, letting the paper absorb as much wax as possible. Using a slotted spoon, carefully remove and place on wax paper to cool. When ready to use, pull out the center about 10 inches (like a cone) and use it to start your fire.

Resources

Roughing It Easy, Dian Thomas,
Dian Thomas Company, Hol-
laday, Utah, 1994

Safety first!

Have your adult helper use the sharp knife and dip the paper into the melted wax. It's hot!

4D. Out and About

R. Roy Hamilton, retired Extension 4-H agent, Oregon State University

Life skills

- Understanding yourself
- Communicating and relating with others
- Problem solving and decision making

Goals

- To understand that respect and manners are not to be forgotten outdoors
- To learn the “clean camp” philosophy

Supplies needed

- Pencil and paper

Here's what's important

Before you begin your outdoor cooking adventure, consider the issue of “respect.” Etiquette and manners are not to be forgotten when you leave your home and venture outdoors. Take your good habits of respecting other people, their property, and the land with you as you go on outdoor adventures. If you are cooking—even in your backyard—you will impact your neighbor’s yard as well your own. Think of your “neighbors” as those who are close to you—at home, in the park, and on a camping trip. Air and noise pollution are ways that neighbors are affected by your outdoor adventure. The closer your neighbors, the more thoughtful your actions must be.

If you're cooking outside, the cooking smoke and odors will move beyond your area. Some odors are desirable while others may not be—especially if you scorch or burn your food! Dried wood produces less smoke. Hardwoods produce less smoke than softwoods such as pine and fir. Using charcoal in a barbecue will not cause a smoke problem after the initial burn.

Noise pollution is an important consideration, too. The more friends you're entertaining, the more noise they will make—generally. Loud “boom boxes” and other sound systems can be offensive. Many cities, towns, parks, and campgrounds have noise rules. Check the rules! Respect your neighbors wherever you are.

If you're going beyond your yard, pets that go with you have many challenges: they must be quiet, well-mannered, kept on a leash, and be cleaned up after. Barking disturbs many of your “neighbors” seeking quiet at a campground. While pets may warn you that other animals are nearby, if your pet challenges a wild animal, its life might be in danger. Pets should always be on a leash in a campground. Is it worth the trouble and risk to take your pet with you, or will it be happier at home?

There's more

You are responsible for keeping our environment clean and safe; this is true at home, too. If you don't take responsibility for keeping trees, flowers, streams, wildlife, campgrounds, and our backyards clean, who will? No matter where you're cooking or camping, when you're done, you must clean up and return everything to its proper spot.

If you're using wood or charcoal in an open area—not within a barbecue or established fire ring—it must be contained. A good

4D. OUT AND ABOUT

fire-pan is simply made from the lid of a metal garbage can. Keep it off the ground with three or four bricks or rocks so it won't burn the grass or other materials under it. You want the area to look like it did before you started cooking—whether it's your yard or a wilderness area.

In the wilderness—or the backyard—this philosophy is called “pack it in, pack it out.” Cooking utensils must be cleaned and returned to the kitchen or camp box. Cooking generates waste material—paper, wrappers, uneaten food, peelings of fruits and vegetables—that must be disposed of in a covered garbage can, not beside the road or in a stream or lake. Don't expect someone else to clean up after you. Leave your “campsite” cleaner than you found it. Good habits carry over throughout all of your life and experiences.

Your fire area, barbecue, or other heat source must be extinguished. The fire source should be cold to the touch. Do not put coals in a garbage can, as they could cause a fire. The safety of people and our environment is your most important consideration. It's up to you!



Let's get into it

Go to a park or campground. Take along a pencil and paper to make notes of ways people respect their “neighbors” and the environment around them. Also jot down ways that people don't show respect. Look at the grounds, the trees, the animals, and the water. Do a little “people watching” as well. If a big group of you went together, did you show respect to each other and to your neighbors in the park? If you took along a picnic lunch for your “respect trip,” did you “pack it in, pack it out” and clean up after others, if necessary?

So what?

Compare notes with your friends and/or adult helper when you return. What could you do differently to show more respect? What will you do differently next time because of this observation trip?

Now what?

What can be done to rehabilitate a park or campground? Talk to a park manager to see what steps they are taking to keep the park the best it can be for everyone.

Pet waste is a serious problem in some urban parks. Many pet owners carry cleanup kits with them when they walk their dog in the park. Some parks even have cleanup stations for pet waste. If your park has a problem with pet waste, think of ways you can improve the situation. How can you work with your local park board and/or city government to improve the situation?

Pet cleanup kit

Always carry a plastic bag and a damp paper towel with you when you take your pet out and about. If your pet leaves a pile, put your hand in the bag and pick up the pile with your bag-covered hand. Pull the bag inside out over the pile, removing your hand. Use the paper towel, if needed, to clean up further.

Chapter 5—Planning Is the Key

5A. Time for Safe Keeping

Nellie Oehler, Extension agent, Lane County, Oregon State University

Here's what's important

Even though your food is safe when you prepare it, if it isn't stored properly prior to eating, it might be unsafe to eat. Select the right containers for transporting and storing foods cooked and eaten outdoors. Gather a variety of containers to judge how well they will keep foods hot or cold. You can put a thermometer inside a container to see how long it keeps the temperature hot or cold. Containers you might have are: insulated lunch sacks, insulated coolers, paper bag, and Thermos® food and beverage containers.

Even if you use an insulated container, you still need to do some things to help keep food hot or cold.

To help cold foods stay cold, freeze juice boxes, water bottles, or commercial ice packs; freeze foods and let them thaw in the lunch box; use frozen bread for sandwiches; add frozen peas or other vegetable to salads; and chill foods thoroughly before putting them in the lunch box.

To help hot foods stay hot: put boiling hot soups in a Thermos®; use containers that have been preheated with boiling water; use microwave-able packs for hot foods; or bring soups and entrees to a boil and place in a pre-warmed insulated container. Do you have other ideas?

Keep everything clean when preparing, serving, and storing foods. Hand washing is the most important thing you can do to keep food clean and safe. If you don't have water where you're cooking outdoors, you can use "wet wipes" or an antibacterial wash as an alternative to hand washing. If you're cooking in a remote area where there is no safe water supply, carry water for drinking, hand washing, and cooking. Heavy, food-grade plastic containers are good for carrying water.

Let's get into it

Microorganism experiment

Watch how microorganisms grow when the conditions are right. Yeast is fun to work with and shows something "growing" fast.

You'll need

- Four clean, plastic or glass 12-oz pop bottles

Life skills

- Problem solving and decision making
- Staying healthy and in good physical condition, and refining coordination
- Making good use of your resources

Goals

- Learn and practice food safety principles when transporting and cooking foods outdoors
- Learn how to manage time to do meal preparation and cooking in a logical order

Supplies needed

- Microorganism experiment supplies (see activity list)
- Variety of lunch containers and sacks including some insulated and some not
- Variety of heat packs and cold packs
- Boxed and/or plastic-bottled juices and drinks
- Assortment of foods that require refrigeration and some that do not
- Moist towelettes, antibacterial wash
- Meal menu ideas
- 3- by 5-inch cards
- Pencils

- A funnel
- Sugar
- Active dry yeast
- Water
- A small bowl of ice
- Chlorine bleach
- Measuring cups and spoons
- Four balloons
- Four rubber bands



Safety first

Have your adult helper handle the chlorine bleach. It is hazardous to your eyes, can irritate your skin, and will damage clothing. Read the label carefully!

Label the bottles #1, #2, #3, and #4. Into each bottle put $\frac{1}{3}$ cup cold water, 1 teaspoon dry yeast, and 1 teaspoon sugar. Into bottle #3 add two drops of chlorine bleach. Shake each bottle well to mix, being careful not to get any bleach on your fingers or clothes. Put a balloon over the top of each bottle and secure it with a rubber band. Place bottle #1 in the refrigerator for 30 minutes. Place bottle #2 in a sunny window, furnace room, or sink with warm water (about 75 to 80°F) for 30 minutes. Place bottle #3 beside bottle #2. Place bottle #4 in a small bowl of ice. Leave for 30 minutes.

When you return, observe the appearance of the bottles and the balloons. When the yeast grows and reproduces, it feeds on the sugar and produces carbon dioxide, a gas that expands the balloon attached to the bottle.

If all goes well, the yeast in bottles #1 and #4 has not grown fast. Bottle #2 with warm water, yeast, and sugar kept at a warm temperature should show the balloon inflating, indicating yeast is reproducing. Bottle #3, under the same conditions as bottle #2, shouldn't show any activity since chlorine bleach kills yeast. If you keep food cold, microorganisms do not grow rapidly. There is rapid growth of microorganisms in the danger zone (40 to 140°F). Chlorine bleach kills the microorganisms. Keep your cooking area clean!

There's more

When preparing meals outdoors, time management is important if the food is going to be prepared and cooked safely and also served on time. In previous lessons, you've learned how to start fires, plan menus, and cook. Now you're ready to put a time schedule together so the food is prepared and cooked in the right order and is "just perfect" when served.

Let's get into it

Here are two simple menus and the steps in preparing the meal. Put each preparation step on a 3- by 5-inch card. Give a card to

5A. TIME FOR SAFE KEEPING

each person, and line up in the order the food would be prepared. Explain why you placed them in that order. Is your order different from the suggested order? Why? When you finish these, make up other menus and put them in the order they would be prepared. Discuss why you put them in that order.

Answers on page 77.

Menu #1 breakfast

Pancakes
Fried eggs
Strip bacon
Orange slices
Hot chocolate

Steps

- A. Heat Buddy Burner
- B. Mix up pancake batter from a mix
- C. Cook pancakes
- D. Fry eggs
- E. Heat fry pan
- F. Cook bacon
- G. Slice the oranges
- H. Heat water for the cocoa and a little extra to keep food warm
- I. Make cocoa
- J. Wash hands
- K. Serve breakfast
- L. Wash dishes
- M. Put out fire
- N. Set out all ingredients and supplies
- O. Heat water for dishes

Menu #2 lunch

Pigs in a blanket (Vienna sausages wrapped in canned biscuit dough) baked on barbecue grill
Fruit kabobs (Assorted fruit on a stick)
Corn on the cob (wrapped in foil and heated on the barbecue)
S'mores

Steps

- A. Light barbecue
- B. Wash hands
- C. Set out all the equipment
- D. Wash the fruit
- E. Cut up fruit and prepare kabobs





- F. Make pigs in blanket
- G. Cook pigs in blanket
- H. Wash corn and wrap in foil
- I. Cook corn
- J. Make s'mores
- K. Eat lunch
- L. Wash dishes
- M. Put out fire
- N. Wash hands again

Deeper we go

Time management also applies to things besides meal preparation. Examples might be getting chores and homework finished on time, and planning for a family camping trip or vacation so everything is on hand. Make a time schedule for one of the above and follow it. Do you put the laundry in the washer before you do the dishes, so you can do both things at once? Do you make calls to state parks requesting information early, so you'll have that to study as you're planning the final details?

Look up information on what food poisoning is and the symptoms of the different kinds of foodborne illnesses. How can they be prevented? Watch for news on food safety problems and food poisoning outbreaks. Discuss how they could have been prevented.

Discuss groups of people who are very susceptible to foodborne illnesses (pregnant women, youth under 5, adults over 65, and the seriously ill). Why does special care need to be taken when preparing and serving foods for this group?

So what?

Plan a hike and have everyone bring a sack lunch. How did you pack your food to keep it safe? What did you do to keep the cold foods cold; the hot foods hot? How do you know all the foods are safe to eat? Was it good packaging for your food? What method of hand washing did you use? How did you plan so there were no leftovers to dispose of?

Plan three menus that you can cook outdoors for your family and friends. Prepare a time schedule for each of the menus. Practice and take notes to see whether you have the time management in the right sequence to have all the food ready to serve at the right time. What is the hardest thing to remember about managing your time? Who could help you do a better job of planning?

Resources

"Get a Jump on Germs," Make Food Safer; a 4-H food safety/microbiology project developed by the departments of Human Development, Animal Science, Food Science, and Human Nutrition for the 4-H Youth Development Program at WSU, Pullman, WA 99164. For additional experiments with microorganisms, hand washing, and food safety, contact your Extension office.

SP 50-771, "We Wish You Well" Food Safety Education Program. Each county office has a Master Food Preserver Notebook which includes this document.

USDA Meat and Poultry Food Safety Hotline,
1-800-535-4555

Now what?

Talk to health care providers about food poisoning that they see in your area.

Ask campers and hikers whether they have ever been sick from the food or water on an outing. What precautions do they use to prevent food- and waterborne illnesses?

What supplies are there available for hikers and campers that can be used to assure a safe food and water supply while camping or hiking in unimproved camping areas or the high country? Research information on safety of water in the streams where you might hike or camp. Research methods used to purify water when you are not sure if the water is safe.

Menu #2 lunch
1. A
2. C
3. B
4. D
5. H
6. F
7. I
8. G
9. N
10. E
11. K
12. J
13. M
14. L

Answers
Menu #1 breakfast
1. N
2. A
3. J
4. B
5. H
6. G
7. I
8. E
9. F
10. C
11. D
12. O
13. K
14. L
15. M

5B. All Decked Out

Virginia Bourdeau, Extension 4-H specialist, Oregon State University

Life skills

- Understanding yourself
- Problem solving and decision making
- Making good use of your resources

Goals

- Understand how to plan a safe, enjoyable outdoor experience.
- Know how to select clothing for an outdoor experience
- Know what items to include in a basic emergency survival kit.

Supplies needed

- Items for Survival Kit
- Long pants
- 6 feet of rope

Here's what's important

People sometimes don't enjoy outdoor activities because they are too hot, too cold, too wet, or bothered by too many bugs. Planning for outdoor activities, including proper clothing and equipment, can make for a safe and enjoyable experience. Good trip planning also means planning for survival. Survivors are people who know what to do in an emergency and are able to do it at the right time.

When planning a trip into the outdoors, find out as much information as you can about the area and its weather conditions before you leave. Never go alone. Leave a trip plan with someone who will take action if your group doesn't return at the prearranged time. Hold a practice session to be sure everyone knows how to use all the equipment being packed. A map and compass will not keep you on track if you don't know how to use them.

To select the correct clothing for an outdoor experience, you must know what types of weather you may find. Collect weather history information for the location and for the season of the year when you'll be visiting. Are sudden rainstorms likely in summer? Might afternoon snow squalls appear after a morning of sun? What temperature is "normal" for that time of year? Your adult helper can help you find this information.

A clothing layering system is the best solution for most outdoor adventures. While you might think they will be too hot, long sleeves for sun protection are a good idea, especially at higher elevations. Your layering system may consist of:

- T-shirt (cotton blend)—long or short sleeve
- Long-sleeve shirt—wool, flannel, or cotton
- Jacket (water resistant or waterproof)—for added warmth, and wind or rain protection
- Long pants (cotton blend in summer, wool in winter)—flannel-lined pants of wool or synthetic fiber are a good solution in winter; denim is not a good choice as it holds lots of water and dries slowly
- Socks—two pairs worn together protect feet best
- Sturdy shoes—tennis shoes might be fine for short hikes; match your footwear to the activity
- Hat—stocking cap or hat with a brim (depending on the season)

There's more

A Survival Kit is a group of items that you carry with you to provide shelter, food, and clothing in an emergency situation. Many outdoor experts object to the term "survival kit" because any kit is only as good as the knowledge of the person using it. If you don't know how to use everything in your survival kit, it cannot help you survive! In addition, a kit must be carried—not left in camp—to be available when you need it. The kit items also may differ depending on your location of travel, the time of year, distance from help, and the number of people in your group.

Consider taking:

- Waterproof matches
- Pocketknife
- Water
- High-energy food source (bars, gorp, etc.)
- Extra clothing layers
- First-aid kit
- Whistle
- Flashlight
- Map of the area
- Compass
- Rain gear
- Sun protection
- Sunglasses for snow or high altitudes
- Toilet paper
- Insect repellent
- Pencil or pen and paper
- Bandana
- Mirror
- Poncho
- Nylon rope, ¼-inch diameter—25 feet



Let's get into it

Research the materials from which outdoor clothing is made: cotton, wool, and man-made (synthetic) materials have specific properties to help keep you warm or cool and protect you from insects, rain, sun, or wind. Plan a trip to an outdoor store. What products are made from which types of materials? What weather conditions are they designed to be used in? Read the labels of a selection of jackets and compare the price of the jacket with the properties it offers such as being windproof, water resistant, waterproof, or "breathable." Which jacket would you select to wear to school? Which jacket would you select if you might be lost in the woods for

Footnote facts

In general, a healthy person can last up to 3 weeks without food if water is available. Most people will survive no longer than 3 days without water.

Humans' internal temperature averages 98.6°F. If a person's internal temperature rises above 105°F or falls below 75°F, serious problems will result, including possible death.

2 days? Why?

Plan for emergencies at home, too! What would happen at your home if the electrical power were off for 2 or 3 days? Would you still have water to drink and wash with? Would you be able to use the toilets? How could you eat or prepare food? How would you stay warm or see after dark? What food supplies should you have on hand in the event of an emergency? If you have pets, how would you keep them safe, warm, and fed? How often should the supplies be reviewed and updated? Plan and make a survival kit for your home.

How does a compass work? Find a person to teach you to read and use a compass. How do you orient a map, using a compass, to ensure you are traveling in the correct direction? What are other ways to determine directions outdoors?

Deeper we go

If you want to hike and don't have a backpack to take along some survival supplies, try making this "on-the-spot" backpack (Figure 1). Lay some long pants on the ground. Close all the fasteners. With a 2-foot length of cord, wrap the end of one leg tightly and bring the rope straight up and through the front belt loop above it. Make a secure knot. Leaving about 8 inches of rope free, bring up the other leg end, wrap it, and tie it securely to the belt loop on the other side of the fasteners. Run another 3-foot-long cord through all of the belt loops, starting at and returning to the middle of the back. Fill the backpack with the important survival items, putting in small items first in the legs, the flat items next to your back (toward the fasteners), and really small items in the pockets. You're ready to go!

So what?

What weather conditions are especially important to be prepared for? Why? How can the type of clothing you bring on a trip help you? What are the important items to include in a survival kit? Where do you keep your survival kit when you're not hiking? How do you make sure it's ready to go at a moment's notice? Why is it important to take it along on every hike?

Now what?

Your adult helper might be able to help you arrange a visit with a member of a local search-and-rescue group to talk about trip planning and equipment selection. Ask them to show you their survival backpack. In what situations have they used their survival backpack?

Figure 1—"On-the-spot" backpack

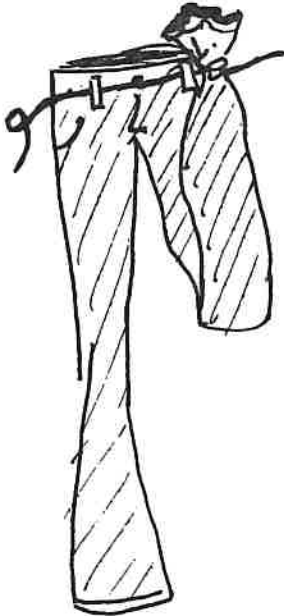

Step 1



Step 2

Resource

Fieldbook, Boy Scouts of America, 1984

5C. Cooking that Shines

Bill Smiley, retired Extension 4-H agent, Linn County, Oregon State University

Here's what's important

Cooking with aluminum foil is fun, gives great results, and is one of the easiest ways to cook in any outdoor setting. It's also very versatile—you can cook individual meals or group meals, and you can use it in the backyard or when camping. It's lightweight, which makes it good for backpacking. In addition, you can cook several foods together, giving you a delicious meal all at one time, and it reduces cleanup time after cooking.

The aluminum foil

Use heavyweight aluminum foil; or, if you use standard weight, double it. Foil can get punctured if folded too tightly or if mishandled, causing moisture and heat to escape. This slows down cooking time in your mini "pressure cooker" and can burn the food.

There are several ways to seal your food inside the foil. The method you choose will depend on what foods you are cooking and your heat source. The two main types of wrap are "Basic Wrap" and "Handle Wrap."

The most common wrap is the Basic Wrap. It can be used in a campfire or grill with flat foods that can be layered. Start with a piece of foil at least three times the size of the food to be cooked. Lay the foil, dull side down, on a flat surface and place the food in the middle, on the shiny side of the foil. Pull the long ends up to form a tent over your food. Holding them together, start making 1-inch folds until the foil is on the food. Then fold both ends over two to three times in the same way (Figure 1). Lay the foil package on top of the coals and turn frequently with your long-handled tongs. Another way is to place five or six coals around and on top of your package using long-handled tongs. Then you won't have to turn your package.

The Handle Wrap is used primarily when the food is not flat, such as an orange, a banana, or an ear of corn. Start by following the Basic Wrap technique, beginning with the tent and folding until it's on the food, but then twist the ends instead of folding them in. Curve the twists upward to create handles for lifting the foil-wrapped food easily out of the coals—especially if you plan to bury the item in coals, like a

Life skills

- Problem solving and decision making
- Finding, understanding, and using information
- Understanding yourself

Goals

- Know how to use aluminum foil for cooking
- Prepare safe and tasty food in foil

Supplies needed

- Good source of heat—either a bed of coals from charcoal briquettes or a wood fire
- Pair of heavy-duty oven mitts or work gloves
- Outdoor cooking apron
- Long-handled tongs
- Heavy-duty aluminum foil (or standard-weight foil folded double)
- Food for one or more recipes

Figure 1

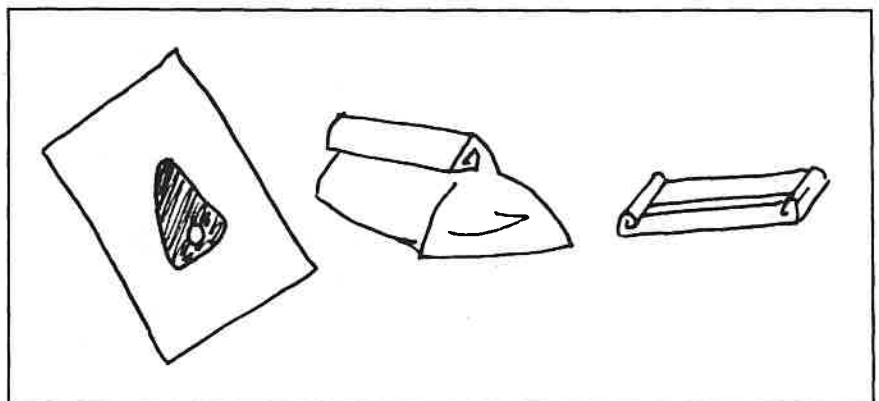

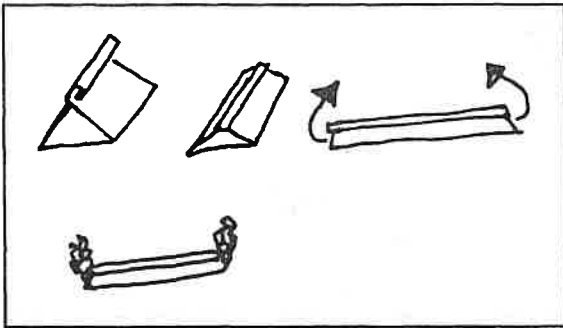

Figure 2

baked potato
(Figure 2).

Seal the foil carefully so the liquid created by the cooking heat is not lost. Cook on a bed of coals with a non-flame ash or orange glow so the food will not burn or scorch. Turn an unburied foil package about every 3 to 5 minutes so the food is cooked thoroughly. Remember food safety! Make sure your ground meat is cooked so the juices run clear. To test the doneness of your food, remove the foil package from the fire with long-handled tongs and carefully

unwrap the hot, sealed package to check the food. If it isn't done cooking, reseal the package and place it back on the coals until done. Always check and eat your food carefully; the steam is hot!

Let's get into it

Baked potatoes

- Select a medium- to large-size baking potato.
- Clean the potato well with a small scrub brush and cold water.
- Rub the potato with shortening or coat it with liquid vegetable oil.
- Poke the potato skin several times with a fork.
- Handle Wrap the potato in foil and bake it over coals until done (usually 45 to 60 minutes, depending on the size of the potato and the heat of your fire).
- Serve with butter, margarine, salt and/or pepper, bacon bits, cheese, and salsa and/or onions.

Foil dinner

- Put food on a sheet of foil three times the width of the food. If you use lightweight foil, use two sheets.
- Start with meat—such as ground meat, slices of ham, cubed meats, fresh fish, hot dogs.
- Add vegetables—such as thin-sliced raw potatoes, onions, or carrots; pieces of raw green pepper; corn, green beans, or peas; or your other favorite vegetables in slices or pieces.
- Season with salt, pepper, and/or your favorite seasonings.
- Use the Basic Wrap, place on coals, and cook until done. Ground meat should be brown, not pink. Turn every 3 to 5 minutes so food will not burn. Unwrap the packet carefully, because hot steam comes out when it is opened!

Pizza (for four)

- Prepare biscuit dough for pizza crust—use homemade or commercial biscuit mix recipe or refrigerated biscuits. Divide dough into four portions. Line four metal pie plates with heavy-duty foil. Lightly oil the foil and spread dough pieces out thinly on each pie

plate.

- Spread on pizza sauce, and place toppings of your choice (pepperoni, sausage, olives, mushrooms, onions, etc.) on top of the crust. Sprinkle shredded cheese(s) over the top.
- Cover each metal pie plate with three layers of heavy-duty foil. Fold or crimp over the edges. Place on coals and cook until done, 10 to 15 minutes. To speed up cooking, place a few coals on top of the foil.
- If you don't have a metal pie plate, use the Basic Wrap with a double layer of heavy-duty foil. Cook on the coals until done, turning every 2 to 3 minutes to keep from burning.
- If you're using refrigerated biscuit dough, flatten one out; add your toppings; flatten another and put it on top, pinching the edges; and cook in a Basic Wrap for your own pizza pocket.
- You can use French bread instead of biscuit dough. Just slice the loaf lengthwise, then cut each length in half for four servings and add the toppings. Basic Wrap and warm until cheese is melted.

Cannon balls

- Cut onion in half—scoop out center of both halves, leaving sides of $\frac{1}{4}$ to $\frac{1}{2}$ inch in thickness.
- Fill both halves of the onion with raw hamburger. Place onion halves together and Handle Wrap with foil.
- Cook on coals until done, usually 15 to 20 minutes.
- The meat should be brown throughout, not pink.

Roasted corn on the cob

- Peel back husks on an ear of corn. Remove silk. Put ear of corn in cold water. Leave under water for 2 to 3 minutes. Remove and pull husks back over corn.
- Handle Wrap in foil and roast on coals for 10 to 12 minutes. Turn frequently (every 2 to 3 minutes) to keep from burning.
- Remove from coals—open up foil and husks.
- Season with butter or margarine and salt and enjoy!

Cupcake in an orange

- Prepare small white or lemon cake mix.
- On a cutting board, slice the top third off a large navel orange; save the top. Scoop out (and eat!) the fruit in the big part, leaving some fruit on the sides and a thin covering on the bottom.
- Fill scooped-out orange $\frac{1}{2}$ full with cake batter. Replace top of orange and wrap in foil using Handle Wrap method. Bake about 20 minutes or until done.

Footnote fact

Bread toasts easily on an open fire using foil. Butter a split biscuit or bread and place buttered side down on a piece of heavy-duty foil. Lay the foil on the grill. The biscuits or bread will brown to perfection in about 5 minutes.





Banana boat—tastes like a banana split!

- Peel back one section of the banana skin. Cut a long, wedge-shaped section in the banana. Remove wedge and fill space with chocolate chips or small pieces of chocolate bar and marshmallows.
- Replace wedge-shaped section and peel on top of filled banana. Handle Wrap the banana skin with foil. Cover with coals and cook until chocolate and marshmallows melt—usually 5 to 10 minutes.

Camp popcorn (for four)

- Lay out four 8-inch-square sheets of heavy-duty foil. Place in the center of each square 2 Tbsp of popcorn and 2 Tbsp of vegetable oil.
- Bring the foil corners together to form a pouch—leaving room for popped popcorn—and seal the open edges tightly.
- Use string to tie the top of the foil pouch to a stick. Using the stick, hold the pouch over hot coals and move it up and down until the popcorn is finished popping.

Deeper we go

Adapt some of your favorite home recipes to foil cooking. When you're at a campground, ask new friends for their favorite foil cooking ideas. Check out an outdoor cooking recipe book in the library and test some of the recipes for foil cooking. Add new favorites to your outdoor cooking file.

So what?

What worked well with your foil cooking? What didn't? Were all the foods cooked at the same time in your packet meal? How can you tell when the coals are just right for cooking in foil?

Now what?

Practice cooking different foods in foil. Collect and share favorite recipes with family and friends. Do a presentation showing others how to cook with foil using both sealing methods. Coordinate a family outdoor foil-cooking experience. Teach them how to use foil to cook their meals on a backyard BBQ or on a camping trip. Remember to teach them safety with the hot packets.

5D. Off We Go

By R. Roy Hamilton, retired Extension 4-H agent, Oregon State University

Here's what's important

Let's go on a hike! Off we go! Out the door! We're gone! WHOA! Where are you going? Who is going with you? Who knows where you're going? How long will you be gone? Do you have the right clothing, hat, and shoes? What food, maps, and emergency supplies are you taking? All these things must be considered before you head out.

Remember, if you don't take it with you, you cannot use it. The time of year will affect the type of clothing and other gear that you take with you. Always take a waterproof jacket and hat. Never start off with a new pair of shoes; blisters will follow—guaranteed! Make sure your shoes are adequate for the type of hike you're going on. It's a good idea to leave an imprint of each hiker's shoe on a piece of foil (step on carpet to imprint) in a visible spot at home—just in case someone is separated from the group.

Where you are going—and for how long—will determine what you take with you. Are you going to the beach or to the mountains; are you going for a day or a week? An urban park and a wilderness area are two very different hiking trips. Regardless of where you are headed, be prepared to face changes in the weather. Have a plan to deal with sudden illness or an accident. These changes can lead to hypothermia and heat exhaustion—life-threatening illnesses.

Hypothermia is when your internal body temperature is reduced to a below-normal level because heat loss from your body exceeds heat gain to your body. This can happen even when the weather is not very cold and also if your clothing becomes wet and you can't get warm and dry. If this happens faster than your body can generate heat, then you become hypothermic. Most people are unaware that it's happening to themselves, but others will notice the early signs—cooler-than-normal skin temperature, shivering and complaining of being cold, difficulty using hands, lack of balance, slurred speech, and drowsiness. The first—and most important—step to take is to get them warm. Help them drink warm liquids; get them in warm, dry clothes; and wrap them in a blanket or sleeping bag—with a warm-bodied friend!

Heat exhaustion can occur when the body gets too hot and not enough natural cooling is keeping the body at the right internal temperature. A person with heat exhaustion will look flushed, feel dizzy or light-headed, and experience profuse sweating (losing water and electrolytes), thirst, nausea, and headache. Get the person into the shade and give them cool water in small sips. Have them take off or loosen any tight, warm clothing, so evaporation can cool

Life skills

- Communication and relating with others
- Problem solving and decision making

Goals

- To organize and take responsibility for a hike
- To pay attention to essential details for hiking health and safety

Supplies needed

- Survival kit
- Food and water
- Proper clothing
- Map
- Camera

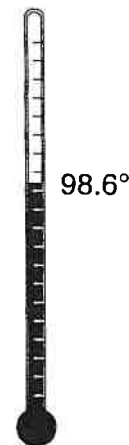



their body. Have them rest a bit until their body temperature comes down. If their body doesn't seem to cool, send someone else out for help and you stay with them. Heat stroke occurs when the body's internal temperature is above 105°F. This is a life-threatening condition that requires medical help. It's important to have water along on a hike—especially a strenuous hike on a warm day—to keep your body working well.

If you're going to the beach, have you checked the local tide table to determine the times for high and low tides? Check the weather forecast for any approaching storms or high wave warnings—waves can and do wash people off rocky outcroppings. If your hike takes you to a National Forest or wilderness area, make sure you have the proper permits for access. If you'll be crossing private property, always ask permission of the landowner; they'll be pleased you asked. This land is their backyard—it just might be a little bigger than yours! Assure the landowner you are a good caretaker of the land, and follow through on your promise.

Who's going along? Make a list of everyone who is going on the hike and leave a copy of the list with all parents. This is especially important if you're going into a wilderness area. This communicates that you're a responsible group leader. Does everyone have permission, so parents/guardians know exactly where and with whom you'll be? This is essential in case anyone becomes lost or injured. If there is a place to register at the trailhead, you must fill in the form completely so the people in charge know how many people are in their area.

Be aware of your surroundings. Are wild animals around? Snakes, bears, cougars, and insects all may live where you're going. Some ideas: If you're in bear country, wear "bear bells" or other "jangle attire" to make sure bears know you're in their area. Keep food covered in your backpack when you're not eating. Put a few drops of ammonia on your pack, so animals don't smell the food.

Food and water are essentials. Plan well, as weight is an important factor—especially on longer hikes. Bring high-energy food and snacks. Don't forget the matches to start a cooking fire (if needed), water, and your first-aid kit. Take a fully charged cellular phone with you for emergencies only, but remember, cell phones don't work in some areas.

Garbage is a concern. Our philosophy is "pack it in, pack it out," right? For human waste and paper, carry it out in an airtight container or bury it (bring a small shovel), if that's an accepted practice in your hiking area. There's nothing worse than finding others' garbage or human waste in a beautiful hiking area. It's up to you!

Let's get into it

Plan a hike with your friends and your helper. Bring your camera to record your hike. Start with a hike that isn't too long or too far from home. Have you taken care of all that's required before you leave home? It's fun to go on a hike—if you're prepared!

Answer all the questions in this brief, hike-planning guide:

- Who is the responsible person?
- Who is the adult to contact regarding arrangements?
- Where are you going?
- When are you returning?
- How are you getting there?
- Where did you leave the list of first and last names of all who are going?
- Does each person have permission from parent/guardian?
- Does each person have adequate shoes, proper clothing, and an adequate supply of water?
- Does any person on medication have an adequate supply with them?
- Do you have a fully charged cell phone?
- Do you have your survival pack and a first-aid kit?
- Do you have a map of the area you're hiking in?

There's more

What kind of hike do you want to take? How about a backwards hike—to see where you've been? Or an ant hike—on your hands and knees within a square foot, to see what's there to discover. A bike hike is fun, too! Make sure bikes are allowed in the area you're thinking about. Take an urban hike to learn about your city with one of the "city fathers." An historical hike with a member of an historical group would help you learn about your area's past. What other kinds of hikes can you think of?

Deeper we go

There are hiking groups specializing in hikes for different ages or places in the world. Do some research to find out what hikes are the most appealing to your age group.

Some people like to bring pets on a hike. What kind of pets would you take on a hike? Will pets be welcome and safe on the hike you're planning? Remember to bring a leash, water, and cleanup bag for your pet!





So what?

How did your planning session go? Did everyone get involved in deciding where you would go and when? Did each person have a responsibility? Was everyone well prepared? How did your hike go? Was everyone prepared? Did everyone treat each other—and the land—with respect?

What is the difference between hypothermia and heat stroke? What are the symptoms of each? What do you need to do for a person with either of these conditions?

Now what?

Write an adventure story about kids on a hike facing one or more challenges and how they handled them.

Make an educational poster or display on how to prepare for a hike, hiking etiquette, hypothermia and/or heat stroke, or another topic related to hiking that interests you.

Chapter 6—We're Off!

6A. Buying Smart

Patti Kelly, former Extension intern, Lincoln County, Oregon State University

Here's what's important

You'll find many "convenience" foods on the shelves of your favorite store. These foods have most of the ingredients in the package and "all you add is..." They provide good food on busy days, especially if you have more money than time. If you have a bit more time, you can make foods from "scratch." That means you start from a recipe and various ingredients and put a food product together. Finally, you can make your own convenience foods and store them for busy times or to take with you for outdoor cooking adventures away from home.

Convenience foods are great for camping because they are light-weight—they rarely include the liquid—and usually are very easy to prepare. Because these packages sit on the shelf a long time, they do not need refrigeration to be safe to eat. Remember, some of the added ingredients do need refrigeration, so read the label carefully.

Let's get into it

Compare prices for macaroni and cheese convenience food and a "scratch" recipe. At home, find a recipe for macaroni and cheese and the number of people it serves. List the ingredients and the quantity of each. Gather a small notebook, pen or pencil, and calculator to take shopping.

At the store, select a packaged macaroni and cheese. How many people does it serve? Check the box for ingredients not included in the mix (like milk and margarine). Find those ingredients and check the amounts you need and the cost of that portion. You'll have some ingredients left over for other recipes! Include the cost of those extra items plus the packaged mix in your calculations. To find the cost per serving, use a calculator to divide the number of servings into the total cost.

Now you're ready to calculate the cost of your scratch recipe. Locate each ingredient your macaroni and cheese recipe calls for. Record the price of each item, along with the quantity you need of each package. Will there be some left for the next time you make the recipe?

Life skills

- Problem solving and decision making
- Finding, understanding, and using information

Goals

- Know how to compare prices
- Figure cost per serving
- Prepare drink mixes

Supplies needed

- Small notebook
- Calculator
- Pen or pencil
- Ingredients for recipes



Example: For macaroni and cheese

2 cups dry macaroni (½ of total package?)

1 can cream-of-mushroom soup

½ can milk (what to do with other half?)

8 ounces cheddar cheese, grated

Total the prices—or portions of the total price, if the whole package is not used. Divide the total price by the number of servings to calculate the cost per serving.

Now compare the prices of the two—both the total costs and the cost per serving. With some foods, it costs less to buy a prepared mix; with other foods, it might be more economical to make your own from scratch. If possible, buy the convenience package and the “scratch” ingredients and make both kinds. How much time does each take? How many dishes does it take to prepare each version? Which tastes the best to you? Can you make your own convenience food to take on a camping trip if you like the “scratch” one better?

Cost of packaged mac & cheese _____	Cost of ingredients for “scratch” mac & cheese _____
Cost of extra ingredients _____	Cost of extra ingredients <u>\$0.00</u>
Total cost _____	Total cost _____
Number of servings _____	Number of servings _____
Cost per serving _____	Cost per serving _____

There’s more

Start collecting “convenience” recipes that you’ve made yourself and are easily used for camping. Beverage mixes are handy to have at home or when you’re camping. Here are a few examples.

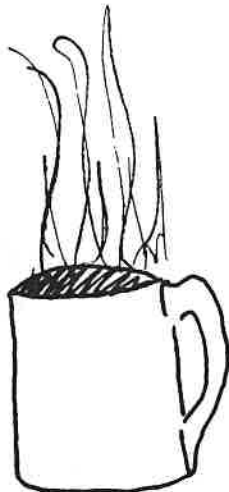

Mocha mix

½ cup unsweetened cocoa

4 ounces instant coffee

1 cup coffee creamer

½ cup powdered sugar

½ tsp cinnamon

Mix dry ingredients in blender. (Optional: for additional flavor, add a vanilla bean after mixing.) Store in airtight container. For use: Mix 2 to 4 tsp in 1 cup of boiling water.

Hot cocoa

1 cup powdered (dry) milk
 1/3 cup coffee creamer
 3 Tbsp cocoa
 1/2 cup powdered sugar
 1/8 tsp salt

Mix the dry ingredients together well. Store in heavy, self-sealing (“zip-lock”) bags. In a cup of hot water, add approximately 3 heaping Tbsp of the mix. Stir well. Makes approximately 6 servings.

Spiced “Russian” tea

1 9-oz jar powdered orange drink
 1 package (quart size) lemonade mix
 1 cup sugar
 1/2 cup instant tea
 1/2 tsp cinnamon

Mix the above ingredients together well. Store in a heavy, self-sealing (“zip-lock”) bag. Stir 3 heaping Tbsp of the mix (or to taste) in a cup of hot water. Mix well.

Trail chocolate milk shake

1/4 cup cocoa
 1/2 cup malted milk powder
 2 cups dry milk
 1 cup powdered sugar

Mix together and store in a self-sealing (“zip-lock”) bag. In camp, mix 1/2 cup mix with 1 cup water in a self-sealing bag, seal the bag, and shake. Makes approximately 8 servings.

“Cool” orange shake

3/4 cup nonfat dry milk powder
 1 cup instant malted milk powder
 3/4 cup powdered orange-drink mix
 1/4 cup sugar

Mix all ingredients together well. Store in a heavy, self-sealing (“zip-lock”) bag. Mix 5 Tbsp with 1 cup cold water and shake well in a covered cup or jar to blend.

So what?

Sometimes it costs less to buy convenience foods than to buy the ingredients for a scratch recipe. What did you find when you tried the package mix? What was the hardest part about making it? How much time did it take? How did it taste to you? How much equipment did you need to cook it? What are some reasons you’d want to make your foods from scratch? What would you have to change to make your “scratch” recipe into a convenience mix? What other convenience foods did you find on the shelves of your market? Which would be good for outdoor cooking?



Now what?

Personal tastes differ. When you come across a recipe that is “too sweet” for your family’s tastes, make changes in the recipe to make it just right for you. Some families are used to more spices than other families. Check out other similar recipes and compare them to these. Which was your favorite beverage mix? What changes did you make in any of the recipes?



Create new convenience packages for the scratch foods you make. You won’t have a fancy box, but you could use a resealing plastic bag to put all the dry ingredients together into one convenient package. Did you add the seasonings? Remember to pack the instructions in the package and the extra non-dry ingredients needed in a cooler.

6B. Cooking on a Stick

Bill Smiley, retired Extension 4-H agent, Linn County, Oregon State University

Here's what's important

Since the beginning of time, humans have used sticks and fire to cook their food. The stick method of cooking is easy, provides tasty results, and requires little equipment and time for cleanup. Cooking on a wooden stick, or sometimes a metal stick or rod, is one of the best ways to cook outdoors.

The stick

You can use several kinds of sticks (sometimes called "skewers"). Metal skewers are available at the store and are made of round or flat food-grade metal, usually with a wooden handle. They can be reused many times, making them "environmentally friendly." Remember to clean and sanitize them thoroughly after each use. The other, and perhaps most common, ones are ½-inch-diameter limbs in 3- to 4-foot lengths, from downed trees (if permitted in your area). Tree varieties such as oak, hickory, alder, and willow are preferred. Avoid using woods like elm, holly, laurel, and yew, as they produce off-flavors in your cooked food. Scrape off the bark and soak the limbs in cold water to help keep the wood from getting too hot—and to prevent its catching fire. If cooking breads on a stick, the diameter of the cooking stick will need to be increased to 1 to 1½ inches.

Because different foods require different cooking times, first you'll need to cook foods that take the longest to be cooked. Place each food item on its own skewer—for example, all onions on one skewer, all meat on another, etc. Cook each skewer-full for the length of time required to cook that item. Put foods requiring the longest cooking time on the coals first. Rotate the sticks frequently so that the food cooks evenly on all sides and doesn't burn. Meat should be cooked until no pink shows and vegetables should be crisp. If food tends to slip on the wood stick, it might be necessary to rough up the surface by cutting notches or small grooves into the surface.

Cut food to be cooked into small pieces (about 1-inch squares) and thread onto the stick. Some meat, such as steak, can be cut into thin strips and threaded onto the stick (Figure 1). Place the stick across the charcoal or wood coals and support it with pieces of wood or rocks across the pit (Figure 2). In some cases, a modified spit or vertical supports can be used to cook food items (Figure 3).



Figure

Life skills

- Problem solving and decision making
- Finding, understanding, and using information
- Communicating and relating to others
- Understanding yourself
- Staying healthy

Goals

- Learn how to cook foods safely on a stick outdoors
- Make a rack for holding your stick cooking

Supplies needed

- Good source of heat—either a bed of coals from charcoal briquettes or a wood fire
- Pair of heavy gloves or oven mitts and heavy apron
- Sticks/skewers—wood or metal
- Sheet metal for rack, tin snips, hammer
- Food and cooking equipment for one or more recipes
- First-aid kit

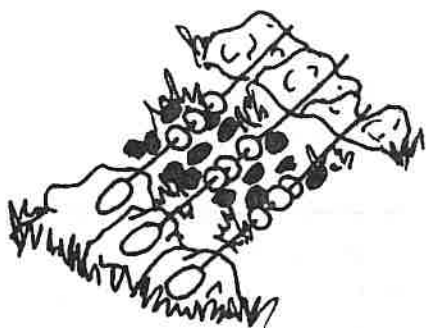

Figure 2

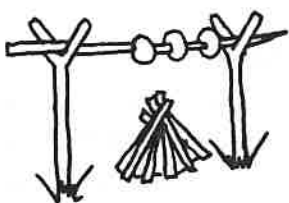

Figure 3

Safety first

Remember, cooking sticks are not toys and must not be used to bother others in your group. Keep them—and yourself—safe!

Let's get into it

Kabobs or shish-kabobs

Kabob is the name of small pieces of meat, vegetables, or fruits put on a skewer or stick and cooked over hot coals. Cut food to be cooked into 1-inch pieces. Arrange the food on trays and let each person make his or her own selection. Alternate pieces of meat, vegetables, or fruits on one kabob, or have one person cook the meat and another the vegetables or fruit, and then share the food.

NOTE: To give the meat a head start, soak it in a basic marinade (a solution to make meat more moist and tender) of 2 parts oil and 1 part vinegar. Herbs and seasonings can be added for additional flavor. Refrigerate the meat in the marinade for 24 hours before cooking. Do not put any more of this marinade on the cooked meat, as it may have bacteria in it. Another way to give meat a head start is to partly precook it before you place it on a skewer, to ensure that the meat is done at the same time as the vegetables and fruits.

Commonly used items for kabobs are:

- Meats: chunks of ham, beef, lamb, pork, chicken, turkey, or hot dogs
- Vegetables: onions, zucchini, mushrooms, canned small potatoes, green peppers, dill pickles, cherry tomatoes
- Fruits: maraschino cherries, pineapple chunks, bananas, apple slices, cherries

Hold sticks over the coals or lay skewers on a grill over the coals. Cook foods 10 to 20 minutes or until done. Turn skewer or stick often and baste with cooking oil or marinade sauce when food appears dry. When food is done enough to suit you, add salt and pepper and slip food onto bread, rice, or noodles.

Pigs in a blanket

Prepare biscuits from biscuit mix or refrigerated biscuits. Roll or press dough out to a thickness of $\frac{1}{4}$ to $\frac{3}{8}$ inch. Cut dough into $\frac{1}{2}$ -inch strips. Run stick or metal skewer through hot dog pieces. Wrap dough strips around hot dog pieces. Place over heat and cook slowly until biscuit dough is golden brown and meat is cooked. Rotate frequently.

Bacon and cheese dogs

Cut hot dog in half lengthwise—but be sure not to cut it all the way through. Spread open the hot dog and add strips of cheddar, Swiss, or other cheese. Close hot dog and wrap strip of bacon around it. Run toothpicks through the bacon and hot dog to hold the hot dog and cheese together. Put stick crosswise through the hot dog. Place over heat source and cook slowly until the bacon is done and the cheese is melted. Rotate frequently.

Stick bread

Take biscuit dough and roll into 1- to 1½-foot lengths, ¼ to ½ inch in diameter. Wrap dough around the end of a green stick in a coil-like manner. Slightly flatten dough so that it sticks to the stick. Toast dough over coals until golden brown, turning frequently so it will not burn. Top with butter, margarine, honey, and/or jam!

Thumbprint bread

Place some biscuit mix in a dish and make a small hole in the center of the mix. Add 1 Tbsp water to the hole. Rotate the end of a ¾- to 1-inch-diameter green stick in the mix until dough forms a ball on the end of the stick. Cook over hot coals until done. Serve with butter, margarine, honey, and/or jam.

Just for fun

S'mores (so good you'll want "some more")

Toast marshmallows on a stick slowly until golden brown. Place four squares of chocolate bar on a graham cracker square. Put toasted marshmallows on top of the chocolate squares. Top with another graham cracker square (as if making a sandwich). Squeeze together, wait a few seconds until the chocolate and marshmallows bond together, and eat!

Shaggy dogs

Heat a pot of water. Remove the lid of a can of chocolate syrup, place the can of syrup in the hot water, and heat the chocolate syrup in the can until hot. Place a marshmallow on a stick and toast it slowly over the coals until golden brown. Dip the toasted marshmallow in the can of hot chocolate syrup, then roll it in a package of shredded coconut, sunflower seeds, or chopped nuts. What a treat!

Deeper we go

Make a kabob rack to hold metal skewers/sticks. To make a rack, purchase a sheet of heavy aluminum (plain or embossed), at least 6 x 28 inches, at a hardware store. Cut with heavy-duty scissors or metal shears. Have your adult helper assist you.

Cut two pieces of the aluminum, 3 x 28 inches each. At the center of each piece, cut out a "V" about ½ inch deep. One inch from the ends, cut ⅛-inch slits halfway up on one and halfway down on the other (Figure 4).

On a sharp-edged block of wood or old table, lay each section so that the "V" is over the edge and hammer edge down. Bend each piece into a sharp, 90-degree corner and attach the two "L-shaped" pieces together at the ⅛-inch slits.



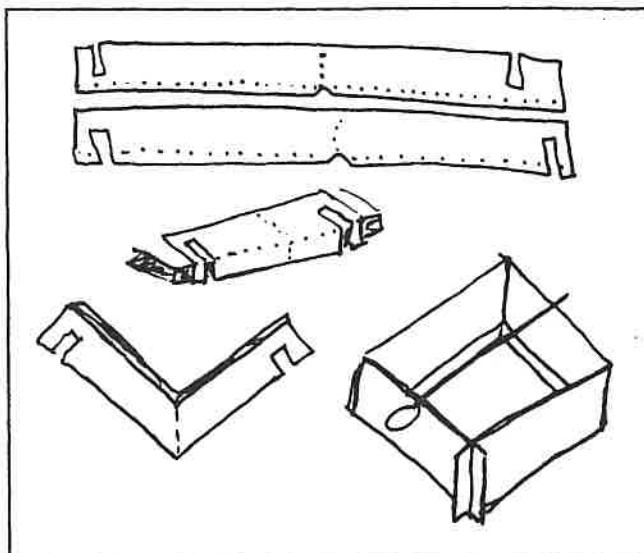

Figure 4—A kabob rack

While the frame is assembled, mark notches on the top by laying a skewer across the top. Keep them at least 2½ inches apart. Cut the sides of the notches and bend inside. To eliminate sharp edges, sand with fine sandpaper.

So what?

What worked best with your stick cooking? What would you change? How could you avoid problems next time? Try both a wooden and a metal stick and compare the results. Which one worked better? When is it better to use a charcoal fire or a wood fire for cooking on a stick? How often should you rotate your stick? How will you know how long to cook different foods so they're cooked just right?

Remember food safety; make sure meat is cooked so that it doesn't have any pink showing and meat juices run clear. Brown your breads slowly to avoid raw, doughy middle parts.

Now what?

Practice using both a wood and a metal stick. Use them with a backyard BBQ grill and in a campground. Involve your family! Teach them to cook with a stick. Collect and share favorite recipes with family and friends.

Do a 4-H club presentation on a tasty dessert cooked on a stick, or making kabobs or bread on a stick.

Make a kabob holder for a friend or neighbor who enjoys cooking outdoors.

6C. The Campfire Grill

Patti Kelly, former Extension intern, Lincoln County, Oregon State University

Here's what's important

Pan-less cookery is quick, easy, and fun with a grill over a campfire. It'll be very similar to your barbecue grill in the backyard, but you'll have to deal with the fire plus balancing the grill on rocks or logs. Go for it anyway! Here's what's important for successful cooking results.

Build the fire early enough to have hot coals for grill cooking. As soon as the coals are red, the fire will be right for cooking meats. High flames make the fire too hot and can burn foods. Allow 15 to 30 minutes for flames to die down—depending on the type of wood you are using. Remember: weather conditions make a difference. If camping on a foggy coast, fires take longer. If camping in a drier climate, fires burn more quickly.

Make sure your grill is made of food-grade metal. Some metals will give off harmful fumes, as they were not meant to be used in a fire. Stainless steel is the best material for a grill. Check those in a camping store to see what they are made of. You can use foil to wrap foods to be cooked on your grill for easy cleanup. Use double layers of foil for extra strength and to keep food from burning.

Foods cooked outdoors taste better—maybe because you're hungrier! Small pieces cook better than one large piece, as it takes a long time for the heat to reach the middle of a large piece of food. Keep seasonings simple. Recommended seasonings are butter, salt, pepper, and some flavored seasonings such as lemon pepper or garlic powder.

Let's get into it

Making your cooking fire grill

Purchase a small grill made of food-grade metal from a sporting goods or hardware store. Leaving a place for the fire in the middle, place rocks or logs across from each other and balance your grill on these. Make sure it doesn't wobble or tip. For meats, use a lower grill height (about 8 inches) or hotter flames. For vegetables, use a 10-inch grill height, low or no flames—when flames first die down. For baked goods, no flame is best, or place the grill at its highest position (12 to 14 inches). You also can purchase a portable folding grill with legs from a sporting goods store.

Build a small cooking fire. When it's burned down a bit, practice using your grill by boiling water in a bag! Yes, water will boil in a paper bag without the bag catching fire! Use any size paper

Life skills

- Problem solving and decision making skills
- Finding, understanding, and using information
- Staying healthy and in good physical condition, and refining coordination

Goals

- Know how and where to place a grill for different foods
- Know how to boil water in a paper bag
- Grill food safely

Supplies needed

- Heavy-duty aluminum foil
- Small grill for barbecue
- Ingredients for recipes
- Wood/briquettes

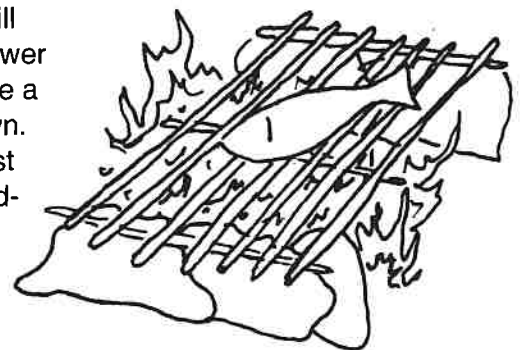



bag. Carefully fold the top down about an inch for extra strength. Pour water into the bag. Place the bag on your grill. Fire should be hot for boiling water. When the water begins to boil, it's ready to use for hot cocoa. Dip in carefully, get your cupful of hot water, and enjoy!

Here are some recipes for cooking on a grill:

Surprise burger

Ground beef	Salt
Sliced onion	Pepper
Grated raw potato (optional)	Cheese slices

With clean hands, press hamburger into a very thin patty. Place a slice of onion, a cheese slice, and a little grated potato on the patty. Form a second thin hamburger patty. Place on top of the fillings. Press the patties together to form a secret pocket filled with a delicious melted surprise. Place directly on grill. Wash hands again. Season the patty to taste with salt and pepper. Turn several times until the meat is no longer pink in the middle. Use a clean knife to poke a hole to check this. Allow about 5 to 8 minutes cooking time for each side. Place it on a bun with your favorite fixin's!

Barbecued chicken

Note: Wash hands thoroughly before and after handling raw poultry. Use different plates and utensils for raw and cooked poultry. Use a sanitizing bleach solution (1 Tbsp bleach to 1 gallon water) to clean cutting surfaces and utensils used for poultry.

Low, even heat is the secret to successful chicken barbecuing. Chicken should be cooked slowly (at low heat to maintain the natural moistness of the flesh) and thoroughly, to penetrate heat to the bone and yet not burn the outside. Start the fire long enough before cooking to have a good bed of coals. Have coals 10 inches away from the meat. Turn the meat often to ensure even cooking. Brush with barbecue sauce often to prevent meat from drying. You'll need:

Chicken pieces, quarters or halves
 Salt (smoked salt is good!)
 Barbecue sauce (heated and mixed well)
 1 cup vinegar
 1/4 lb butter
 1/4 cup water
 1 Tbsp salt

Salt the chicken well. Place the chicken on the grill with the skin side up. Baste immediately or wait until the skin and cut side begin to dry a bit. Use a pair of tongs to turn the chicken every 2 to 5 minutes, depending on how hot the fire is. Baste often. Watch the first

6C. THE CAMPFIRE GRILL

three or four turnings carefully; don't let the skin brown too rapidly. Cook twice as long with the cut side down as the skin side down. Cook approximately 1 hour for halves and less time for smaller pieces. To test for doneness on half a chicken, twist the drumstick. The chicken is done when the leg bone will twist in the socket easily or if the flesh around the hip joint is white. If it's still pink, put the chicken back on the grill and cook another 15 minutes. Do not serve under-cooked chicken.

There's more

Biscuits cooked in foil

One can of biscuits, or a batch of biscuit mix

Two pieces of heavy-duty aluminum foil, 10 to 12 inches long

Spoon dough or place canned biscuits on oiled, double thickness of foil. Make a loose Basic Wrap, leaving room for biscuits to expand. Place the foil-wrapped biscuits on the grill and bake, turning after 8 minutes several times to brown on both sides. Cook 10 to 15 minutes.

Deeper we go

Try some of the foil recipes that you've learned in previous lessons on the grill vs. in the coals. Which ones work both ways? Which ones work better on the grill?

Foil takes a lot of energy to produce. How can you recycle foil to use it several times? On a backpacking trip, foil provides a light-weight cooking "utensil." How would you keep it usable throughout your whole trip? How will you clean it between uses so bacteria won't grow?

So what?

What method did you use to keep your grill the correct distance from the fire? Did it remain stable? What alternatives could you use? Was your grill the correct distance from the fire for your food to cook well?

Now what?

There are many recipes for marinades (to soak your meat ahead of time in the refrigerator) and barbecue sauces to brush on your meats while they're cooking. Try several different commercial brands from the store and make some of your own. Here's a recipe to try.

Sauce for barbecued meats

¼ cup chopped onion



6C. THE CAMPFIRE GRILL

¼ cup salad oil or 3 Tbsp butter

½ cup catsup or tomato sauce

¼ cup vinegar

½ cup water

2 Tbsp sugar

1 Tbsp prepared mustard

¼ tsp salt

¼ tsp pepper

Fry onions in oil or butter. Add the other ingredients and simmer for 15 minutes. Brush on sauce while hamburgers are cooking.

Compare the cost and flavor of this sauce to commercial brands. Which do you like best?

6D. We're Tenting Tonight

Beth Upshaw, Extension 4-H program assistant, Union County, Oregon State University

Here's what's important

A camping trip requires more planning than a vacation in a city because you take with you everything you need to be warm and well fed. While you know how to pack a suitcase for yourself, you also must learn to pack food and shelter for a camping trip! Work with your friends and your adult helper—you'll have fun with this big job! For your first summer camping trip, go to an established campground with potable (drinkable) water. Some campgrounds even have showers!

Let's get into it

Using your state map, find your town. Locate campgrounds in your area. Often there's a little tent printed on the map for established campgrounds, but don't overlook smaller public or private campgrounds. Contact your state and county park and forestry departments for brochures and information.

Determine where you will go and how many people are going, gather your camping and cooking supplies, plan your meals, and buy the food you will use. Investigate the wildlife in the area and probable weather conditions. Work with your adult helper as you plan your overnight camping adventure. Answer these questions as you plan.

Campsite

Where is the campsite? How long will it take to get there? Are reservations needed? What is the cost? [\$] How many campers/tents/vehicles are allowed per campsite? Do you need to guarantee a campsite? What is the check-in/check-out time? What facilities does it have (potable water, toilets, showers, firewood, recreation activities...)? Does it have a lake/creek/swimming hole/swimming pool? Are the tent spots on gravel, dirt, or grass? Will you need tarps or pads? Is there a campfire pit or other cooking fire facility? Are there wild animals at the campground? Is there an educational program to learn about them? Are pets allowed? What are the requirements for pets?

Camp supplies

Do you have tents, lanterns, and cooking equipment? Does each person have a sleeping bag? If you're hiking, do you have a complete "survival backpack"? Do you have to purchase any additional supplies? [\$]

Life skills

- Understanding yourself
- Communicating and relating with others
- Problem solving and decision making
- Finding, understanding, and using information
- Working with groups

Goals

- Establish a budget and purchase supplies for a camping trip
- Plan and pack for a camping trip for your group/family
- Set up a campsite and cooking area

Supplies needed

- Map
- Camping trip budget
- Food list based on menu
- Camping supply list
- Sturdy boxes
- Tent
- Sleeping bag
- Cooking utensils
- Paper and pencil

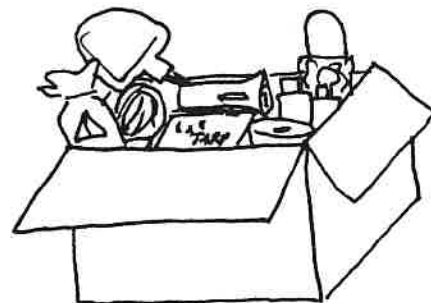

Transportation

What kind of and how many vehicles will you need for your campers and gear? Are there seat belts for everyone in the vehicle(s)? What adults can accompany you to drive and chaperone? What will be the cost of transportation? [\$]

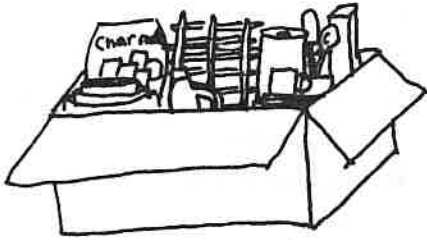

Food

Which meals will you eat “on the road” [\$] and which at the campsite? [\$] What food, supplies, and equipment are needed to prepare, eat, and clean up meals on your menu? Do you have a plan to involve everyone in food preparation and clean up?



Activities

What sites are there to see along the way? How much do they cost? [\$] What campground games and activities are fun and quiet, so as not to disturb other campers? What activities work for all—no matter what their abilities?

Make a budget

A budget is a spending plan to reach a goal. Balance the money you need for your camping trip with how much money you can spend. You must know how much money you have first and spend only that, or you could figure the costs you will have and earn the money. Do a fund-raising activity like a neighborhood carwash!

As you prepare your budget, go over everything that has a dollar sign [\$] in the questions above. Are the meals figured by how much each person will eat or by what the total cost of meals is? If each person contributes money equally, figure out what meals cost for each person (cost/person), divide the campground and gas costs by the number of people going, and add it all up so each person knows how much it will cost.

Cost/person	Income/person
Food/person \$ _____	Fund-raiser share \$ _____
Supplies/person \$ _____	Personal money \$ _____
Transportation/person \$ _____	Savings \$ _____
Fees/person \$ _____	Other support \$ _____
Total/person \$ _____	Total/person \$ _____

The two columns of numbers (costs and income) should total the same, so you don't spend more money than you have.

There's more

Make lists for your camping trip. Think through and write down the steps of each meal, everything you'll do, and the equipment you'll

6D. WE'RE TENTING TONIGHT

need. This keeps you organized, and you'll have everything when you need it.

Here's a basic checklist; add your own special items to the list—especially your menus and food!

General camping supplies

- | | |
|--|--|
| <input type="checkbox"/> Flashlight with extra batteries | <input type="checkbox"/> Lantern |
| <input type="checkbox"/> Rope and string | <input type="checkbox"/> Shovel |
| <input type="checkbox"/> Tent, all stakes, and poles | <input type="checkbox"/> Tarp |
| <input type="checkbox"/> Water containers | <input type="checkbox"/> Pet food and dish (?) |
| <input type="checkbox"/> Matches | <input type="checkbox"/> Toilet tissue |

Personal camping supplies

- | | |
|---|---|
| <input type="checkbox"/> Sleeping bag | <input type="checkbox"/> Clothing for warm/cold weather |
| <input type="checkbox"/> Pillow | |
| <input type="checkbox"/> Camera and film | <input type="checkbox"/> Padding for sleeping bag |
| <input type="checkbox"/> Sturdy shoes, no sandals | <input type="checkbox"/> First-aid kit |
| <input type="checkbox"/> Survival backpack | <input type="checkbox"/> Pocket knife |
| <input type="checkbox"/> Mess kit | <input type="checkbox"/> Personal spending money |
| <input type="checkbox"/> Personal items (toothbrush, towel, etc.) | |

Cooking and cleaning equipment (based on your menu)

- | | |
|---|--|
| <input type="checkbox"/> Mixing bowls, pots and pans | <input type="checkbox"/> Dish soap, bleach |
| <input type="checkbox"/> Knives and peelers | <input type="checkbox"/> Spoons and spatulas |
| <input type="checkbox"/> Charcoal or firewood | <input type="checkbox"/> Dish pans (three) |
| <input type="checkbox"/> Gas cook stove and fuels (?) | <input type="checkbox"/> Foil and plastic bags |
| <input type="checkbox"/> Dish cloths and towels | <input type="checkbox"/> Garbage bags |
| <input type="checkbox"/> Lighter fluid | <input type="checkbox"/> Plates, cups, bowls |
| <input type="checkbox"/> Silverware | <input type="checkbox"/> Paper towels/napkins |
| <input type="checkbox"/> Tablecloth (vinyl cleans easily) | <input type="checkbox"/> Grill |
| <input type="checkbox"/> Heat-proof gloves | <input type="checkbox"/> Ice chest |

Let's go shopping

There are many stores that sell camping supplies and food. Check several and compare prices for the items you need. Bring your budget, your menu, and your camping supplies lists. Divide into two groups, check prices, and come back together to compare. Which stores have the best prices? Stay within your budget. Purchase camping supplies and food; store non-refrigerated items in dry plastic containers. Purchase refrigerated items a day before you leave and keep them cold. Buy or make ice for the ice chest.



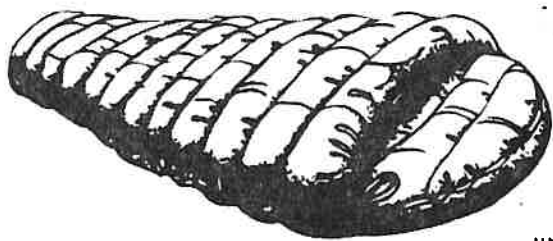

Let's pack!

Everyone can help organize the camping trip and pack the vehicles. Using the checklist, pack your personal gear.

Next divide into three groups: 1) pack cooking equipment; 2) pack the food; and 3) pack general camping supplies.

Use sturdy boxes that are not too large; pack the heavy items in the bottom. Keep items that will be used together packed together. Pack the heavy boxes into the vehicles first so they don't crush more fragile things. Get help from an adult for especially heavy items.

Have you left your itinerary and emergency phone numbers with parents, guardians, and/or a neighbor? Have you left an imprint of your shoe or boot on a piece of aluminum foil (place foil on carpet and step down firmly), in case you're separated from your group during a hike and someone needs to track you? Bring a few car games and songs for the trip!

Set up camp

When you get to the campground, check in at the registration area, if there is one. Register your campsite so people know where to find you in case of an emergency. Your campsite should meet your needs:

- Is there a suitable cooking area established and a table for preparing food?
- Is it safe from potential dangers (cliff, overhanging rocks, dead trees)?
- Is it dry, not wet or swampy?
- Are there a lot of insects (bees, ants)?
- Is the ground level enough for tents?

If the campsite you were assigned does not meet these needs, check back at registration for a more suitable site. Once you've decided on your site, unload the supplies. Divide the group:

1) Tent area

Make sure the ground is flat and free from holes, bumps, roots, and rocks. If the camp rules allow, put a tarp under the tent to keep ground moisture from getting into your tent and sleeping bag.

2) Cooking and eating area

Make sure the area is clean to start with and stays clean while you prepare food. Put cooking stoves and other heat source in the cooking area. Have a clean food-preparation area. If you have picnic tables, clean the table and spread a tablecloth. If not, spread a tarp on the ground and spread your tablecloth on it.

3) Storage area

All food must be kept in a tight container—dry foods in a plastic container and refrigerated foods in an ice chest. One of the best ways to keep the food organized is in a non-sleeping tent in covered containers. Don't leave food out as it will attract animals. Organize your food by meals or by categories—for example, all breads and cereals together, all fruits and vegetables together.

It's time to cook!

Make sure everyone participates in preparing meals in some way. Work in the following suggested groups.

- 1) Mealtime Preparation Crew—Clean off table, wash and sanitize, set table if needed, fetch and heat water for food preparation and clean up.
- 2) Food Preparation Crew—get out food, wash hands, wash, slice, and mix food.
- 3) Fire Makers—gather wood, prepare and guard the heat source for cooking.
- 4) Cooks—prepare the meal.
- 5) Waiters—serve the food, keep things orderly, and store only nonperishable leftovers. If in doubt, throw it out! Most importantly, enjoy the food and fun with your friends!

Everyone gets to clean up!

Each person must be responsible for washing your own “mess kit.” One group can clean the food preparation dishes and another the campfire/cooking area, while others prepare for the next activities. The following hints will help clean-up go quickly.

The Mealtime Preparation Crew boils water in a large kettle. Carefully pour some in three dishpans. Add cold water to the hot wash water to make it the right temperature to get your hands into. Add a little liquid detergent—too much detergent is hard to rinse off. Wash the cleanest-looking dishes first, dirtier looking dishes next, and, last of all, the greasy things. If you have a hard-to-clean pan, put some water in it and boil until food particles come off.

In the second pan, rinse dishes well in hot water. Remember, soap can make you sick, so get it all off! In the third pan, have a second rinse with bleach (1 Tbsp/gallon of water) to sanitize the dishes. Let dishes air dry on the table or in a mesh bag hung on a branch.

Deeper we go

Leave the campsite cleaner than when you found it. Pick up all garbage—anything not found naturally in the woods—in your camping area, and pack it out or dispose of it in garbage cans if provided. Here's a fun activity: Have a scavenger hunt—everyone can par-



Resources

Roughing It Easy, Dian Thomas,
Dian Thomas Company,
1994.

ticipate. Divide into twos and set the boundary lines and time limit. Send everyone out to pick up garbage. Place a plastic bag over your fingers to protect you from touching "yucky" stuff. When everyone gets back, see who has the most garbage and the most unique piece of garbage. Give that team a special surprise.

So what?

Talk about what you have learned about organizing a camping trip and what you would do differently next time. What plans went well? What needs more planning? How was the food? What could have made it better? Did everyone have adequate shelter and warmth?

Now what?

You have learned a lot of planning and organization skills now. In what other areas of your life can you use these skills? An important skill that planners use is keeping everything together in one place. Were all of your plans together in one place? Did you forget something because one list was not with the others? What system can you use for keeping everything together? Talk to a person who plans activities for their job. What do they do to make sure no details are overlooked?

